

---

# **HP 8130A Programmable Pulse Generator Operating and Programming Manual Including Options 001 and 020**

## **SERIAL NUMBERS**

This manual applies to all instruments.



**HP Part No. 08130-90011; Microfiche Part Number:  
08130-95011**

**Printed in the Federal Republic of Germany**

**First Edition  
E1089**

This document contains proprietary information which is protected by copyright. All rights are reserved.

No part of this document may be photocopied, reproduced, or translated to another language without the prior written consent of Hewlett Packard GmbH.

© Copyright 1989 by:  
Hewlett-Packard GmbH  
Herrenberger Str. 130  
7030 Boeblingen  
Federal Republic of Germany

---

## Printing History

New editions are complete revisions of the manual. Update packages, which are issued between editions contain additional and replacement pages to be merged into the manual by the customer. The date on the title page and back cover of the manual only changes when a new edition is published. When an edition is reprinted, all the prior updates to the edition are incorporated. No information is incorporated into a new edition unless it appears in a prior update.

Control Serial Number: Edition 1 applies directly to all instruments.

### Printing History

<u>Edition</u>	<u>Date</u>	<u>Part Number</u>	<u>CODE</u>
Edition 1	3rd October 1989	08130-90011	E0889

---

## Safety Considerations

The Model IIP 8130A is a Safety Class 1 instrument (instrument with an exposed metal chassis that is directly connected to earth via the power supply cable). The symbol used to indicate a protective earth terminal in the instrument is .

Before operation, the instrument and manual, including the red safety page, should be reviewed for safety markings and instructions. These must then be followed to ensure safe operation and to maintain the instrument in safe condition.

Power is supplied to some of the IIP 8130A circuits at any time that the instrument is connected to the AC power source.

To disconnect from the line power, disconnect the power cord either at the rear power-inlet or at the AC line-power source (receptacle). One of these must be accessible at all times. If the instrument is installed in a cabinet, it must be disconnected from the line power by means of the system's line-power switch.

■ **Initial Inspection**

Inspect the shipping container for damage. If the container or cushioning is damaged, it should be kept until the contents of the shipment have been checked for completeness and the instrument has been verified both mechanically and electrically.

Procedures for checking the operation of the instrument are given in the Performance Tests. If the contents are incomplete, mechanical damage or defect is apparent, or if an instrument does not pass the operator's checks, notify the nearest Hewlett-Packard office. Keep the shipping materials for carrier's inspection. The HP office will arrange for repair or replacement without awaiting settlement.

**Warning**



---

**To avoid hazardous electrical shock, do not perform electrical tests when there are signs of shipping damage to any portion of the outer enclosure (covers, panels, etc.).**

---

## ■ Power Requirements

### Caution



---

Before applying AC line power to the HP 8130A, ensure that the voltage selector on rear panel of the HP 8130A is set for the proper line voltage and the correct line fuse is installed in the fuse holder. Procedures for changing the line voltage selector and fuse are contained in the following section "Line Voltage Selection".

---

The HP 8130A can operate from any single-phase AC power source supplying 100 V, 120 V, 220 V or 240 V in the frequency range from 50 to 60 Hz (see Table 0-1). The maximum power consumption is 250 VA with all options installed.

**Table 0-1. Line Voltage Ranges**

Selector Voltage	AC Voltage Range
100	90 - 110 V
120	108 - 132 V
220	198 - 242 V
240	216 - 264 V

## ■ Line Voltage Selection

### Caution



---

**BEFORE SWITCHING ON THE INSTRUMENT**, make sure that the instrument is set to the local line voltage and the correct line fuse is installed in the fuse holder.

---

The line voltage selector is set at the factory to correspond to the most commonly used line voltage of the country of destination. The switch is combined with the power line voltage receptacle on the rear panel. Refer to Table 0-1 for the line voltage ranges

and Table 0-2 to set the line voltage and select the appropriate fuse.

**Table 0-2. Line Voltage and Fuse Selection**

Line Voltage	Fuse Type	HP Part Number
100 V / 120 V	T 3A, 250 V	2110-0029
220 V / 240 V	T 1.5A, 250 V	2110-0304

To change the line voltage and fuse:

1. Remove the power cord.
2. Insert a screwdriver into the recess at the side of the assembly.
3. To change the voltage setting, the selector must be removed and then replaced with the new setting value displayed.
4. If necessary, change the fuse in accordance with the new voltage setting.

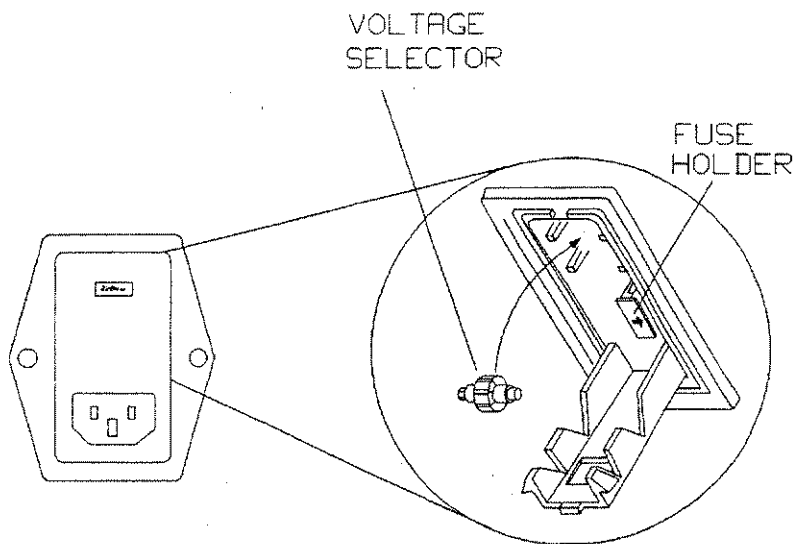

**Figure 0-1. Line Voltage Switch Assembly**

■ **Power Cable**

In accordance with international safety standards, this instrument is equipped with a three-wire power cable. When connected to an appropriate AC power receptacle, this cable grounds the instrument cabinet. The type of power cable shipped with each instrument depends on the country of destination. Refer to Figure 0-2 for the part numbers of the power cables available.

**Warning**



To avoid the possibility of injury or death, the following precautions must be followed before the instrument is switched on.

- If this instrument is to be energized via an autotransformer for voltage reduction, ensure that the Common terminal is connected to the grounded pole of the power source.

- The power cable plug shall only be inserted into a socket outlet provided with a protective ground contact. The protective action must not be negated by the use of an extension cord without a protective conductor.
- Before switching on the instrument, the protective ground terminal of the instrument must be connected to a protective conductor. This is verified by using the power cord which is supplied with the instrument.
- Intentional interruption of the protective ground connection is prohibited.

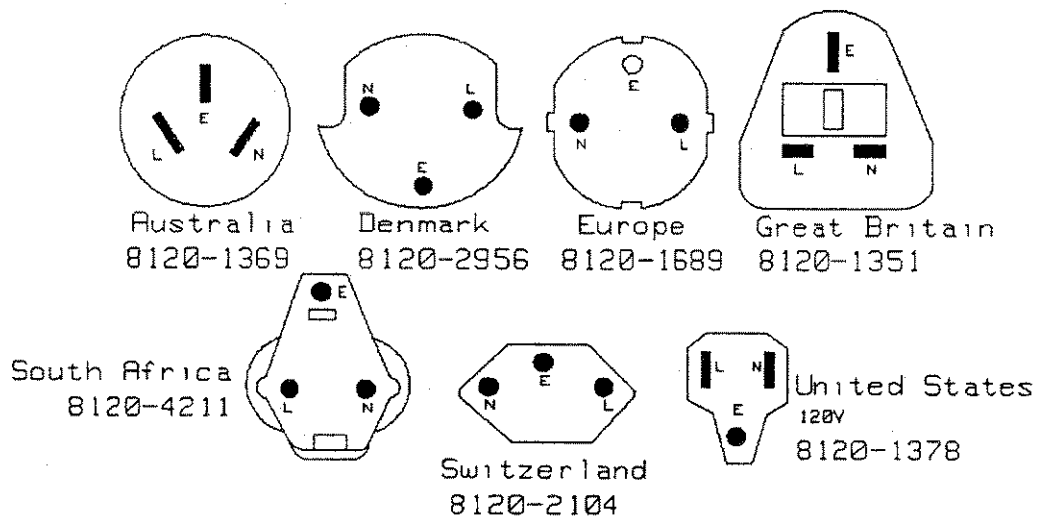

**Figure 0-2. Power Cables - Plug Identification**

The following work should be carried out by a qualified electrician - all local electrical codes being strictly observed. If the plug on the cable does not fit the power outlet, or the cable is to be attached to



a terminal block, cut the cable at the plug end and re-wire it.

The color coding used in the cable will depend on the cable supplied. If a new plug is to be connected, it should meet local safety requirements and include the following features:

- Adequate load-carrying capacity (see table of specifications).
- Ground connection.
- Cable clamp.
- Input/Output Signals



**Caution**



---

The maximum external voltages which can be applied to the inputs and outputs of this instrument are as follows:

External Input  $\pm 10V$

Trigger Output

+7V, -2V

Main Output  $\pm 5V$

---

■ Operating Environment

The following summarizes the HP 8130A operating environment ranges. In order for the HP 8130A to meet specifications, the operating environment must be within these limits.

**Warning**



---

The HP 8130A is not designed for outdoor use. To prevent potential fire or shock hazard, do not expose the HP 8130A to rain or other excessive moisture.

---

- Temperature

The HP 8130A may be operated in temperatures from 0°C to 55°C.

- Humidity

The HP 8130A may be operated in environments with humidity up to 95% (0°C to +40°C). However, the HP 8130A should be protected from temperatures or temperature changes which cause condensation within the instrument.

- Instrument Cooling

The HP 8130A is equipped with a cooling fan mounted inside the rear panel. The instrument should be mounted so that air can freely circulate through it. When operating the HP 8130A, choose a location that provides at least 75 mm (3 inches) of clearance at the rear, and at least 25 mm (1 inch) of clearance at each side. Failure to provide adequate air clearance will result in excessive internal temperature, reducing instrument reliability.

- Storage and Shipment

The instrument can be stored or shipped at temperatures between -40°C and +75°C. The instrument should be protected from temperature extremes which may cause condensation within it.

---

## Introduction

This manual is arranged into four categories:

- Instrument Description  
Descriptions of selected operating principles:  
Chapter 1, Chapter 2, Chapter 3, and Chapter 4
- Quick Reference Guide  
Local control and remote control programming  
information: Chapter 5, Chapter 6 and Chapter 7
- Reference Data  
Supporting information of a non-operational nature:  
Appendices A to H
- Customer Assistance  
Sales and Service information: Appendix I.

Application programming level knowledge of *IEEE Standards 488.1-1987* and *488.2-1987* is desirable for remote control programming of the HP 8130A.

Appendix G contains cross reference information for earlier instrument languages and the HP8130A language which is based on *IEEE Draft Standard 488.2-1987*

---

## Notices

### Subject Matter

The information in this document is subject to change without notice.

*Hewlett-Packard makes no warranty of any kind with regard to this printed material, including, but not limited to, the implied warranties of merchantability and fitness for a particular purpose.*

Hewlett-Packard shall not be liable for errors contained herein or for incidental or consequential damages in connection with the furnishing, performance, or use of this material.

### Front Cover Photograph

The instrument photograph on the front cover shows the HP 8130A with OPTION 020 installed.

---

## Limited Warranty

### Warranty

This Hewlett-Packard instrument product is warranted against defects in material and workmanship for a period of one year from date of shipment. During the warranty period, HP will, at its option, either repair or replace products which prove to be defective.

For warranty service or repair, this product must be returned to a service facility designated by HP. Buyer shall prepay shipping charges to HP and HP shall pay shipping charges to return the product to Buyer. However, Buyer shall pay all shipping charges, duties, and taxes for products returned to HP from another country.

HP warrants that its software and firmware designated by HP for use with an instrument will execute its programming instructions when properly installed on that instrument. HP does not warrant that the operation of the instrument, software, or firmware will be uninterrupted or error free.

### Limitation of Warranty

The foregoing warranty shall not apply to defects resulting from improper or inadequate maintenance by Buyer, Buyer-supplied software or interfacing, unauthorized modification or misuse, operation outside of the environmental specifications for the product, or improper site preparation or maintenance.

No other warranty is expressed or implied. Hewlett Packard specifically disclaims the implied warranties of Merchantability and Fitness for a Particular Purpose.

**Exclusive Remedies**

The remedies provided herein are Buyer's sole and exclusive remedies. Hewlett Packard shall not be liable for any direct, indirect, special, incidental, or consequential damages whether based on contract, tort, or any other legal theory.

**Assistance**

Product maintenance agreements and other customer assistance agreements are available for Hewlett-Packard products. For any assistance contact your nearest Hewlett-Packard Sales and Service Office. Addresses are provided at the back of this manual.

**Certification**

Hewlett-Packard Company certifies that this product met its published specifications at the time of shipment from the factory.

Hewlett-Packard further certifies that its calibration measurements are traceable to the United States National Institute of Standards and Technology, NIST (formerly the United States National Bureau of Standards, NBS) to the extent allowed by the Institute's calibration facility, and to the calibration facilities of other International Standards Organization members.



## **Radio Frequency Interference Statement Deutsche Bundespost**

(Federal Republic of Germany only)

### **Hersteller Bescheinigung**

Hiermit wird bescheinigt, dass das Geraet, Pulsgenerator-HP8130A, in Uebereinstimmung mit den Bestimmungen von Postverfuegung 1046/1984 funkentstoert ist.

Der Deutschen Bundespost wurde das Inverkehr bringen dieses Geraetes angezeigt und die Berechtigung zur Ueberpruefung der Serie auf Einhaltung der Bestimmungen eingeraeumt.

Zusatzinformation fuer Mess- und Testgeraete:  
Werden Mess- und Testgeraete mit ungeschirmten Kabeln und/oder in offenen Messaufbauten verwendet, so ist vom Betreiber sicherzustellen, dass die Funkenstoerbestimmungen unter Betriebsbedingungen an seiner Grundstuecksgrenze eingehalten werden.

### **Manufacturers Declaration**

This is to certify that the HP 8130A Pulse Generator operates in accordance with the radio frequency interference requirements of Deutsche Bundespost (German Post Office) Directive FTZ 1046/1984.

The German Post Office was notified that this equipment was put into circulation. The German Post Office retains the right to check future Hewlett-Packard model HP 8130A instruments for compliance with directive FTZ 1046/1984.

Additional information for test and measurement equipment:

If test and measurement equipment is operated with unshielded cables and/or used for measurements on open set-ups, the user must assure that, under operating

conditions, the radio interference limits are still met at the border of his premises.



---

## Safety Summary

The following general safety precautions must be observed during all phases of operation, service, and repair of this instrument. Failure to comply with these precautions or with specific warnings elsewhere in this manual violates safety standards of design, manufacture, and intended use of the instrument. Hewlett-Packard Company assumes no liability for the customer's failure to comply with these requirements.

**General** This is a Safety Class 1 instrument (provided with terminal for protective earthing) and has been manufactured and tested according to international safety standards.

**Operation - Before applying power** Comply with the installation section. Additionally, the following shall be observed:

- Do not remove instrument covers when operating.
- Before the instrument is switched on, all protective earth terminals, extension cords, auto-transformers and devices connected to it should be connected to a protective earth via a ground socket. Any interruption of the protective earth grounding will cause a potential shock hazard that could result in serious personal injury.
- Whenever it is likely that the protection has been impaired, the instrument must be made inoperative and be secured against any unintended operation.
- Make sure that only fuses with the required rated current and of the specified type (normal blow, time delay, etc.) are used for replacement. The use of repaired fuses and the short-circuiting of fuseholders must be avoided.
- Adjustments described in the manual are performed with power supplied to the instrument while protective covers are removed. Energy available at many points may, if contacted, result in personal injury.
- Any adjustments, maintenance, and repair of the opened instrument under voltage should be avoided as much as possible, and when inevitable, should be carried out only by a skilled person who is aware of the hazard involved. Do not attempt internal service or adjustment unless another person, capable of rendering first aid and resuscitation is present. Do not replace components with power cable connected.

- Do not operate the instrument in the presence of flammable gases or fumes. Operation of any electrical instrument in such an environment constitutes a definite safety hazard.
- Do not install substitute parts or perform any unauthorized modification to the instrument.
- Capacitors inside the instrument may still be charged even if the instrument has been disconnected from its source of supply.

### Safety Symbols



The apparatus will be marked with this symbol when it is necessary for the user to refer to the instruction manual in order to protect the apparatus against damage.



Indicates dangerous voltages.



Earth terminal.



Protective earth.

### Warning



The **WARNING** sign denotes a hazard. It calls attention to a procedure, practice or the like, which, if not correctly performed or adhered to, could result in injury or loss of life. Do not proceed beyond a **WARNING** sign until the indicated conditions are fully understood and met.

### Caution



The **CAUTION** sign denotes a hazard. It calls attention to an operating procedure, practice or the like, which, if not correctly performed or adhered to, could result in damage to or destruction of part or all of the equipment. Do not proceed beyond a **CAUTION** sign until the indicated conditions are fully understood and met.

### Safety Summary

# Contents

---

<b>1. General</b>	
Introduction . . . . .	1-1
Instrument Features . . . . .	1-1
Pulse Generator Definitions . . . . .	1-3
HP-IB Programming Times . . . . .	1-10
<b>2. Operation</b>	
Power-On . . . . .	2-1
Power-On Self-Test . . . . .	2-1
Normal State . . . . .	2-1
Power-On Error Condition . . . . .	2-2
Power-Off . . . . .	2-2
Instrument Setting . . . . .	2-2
Programming of Parameters . . . . .	2-3
Local Programming . . . . .	2-3
Function Selection and Data Entry . . . . .	2-3
Device Errors . . . . .	2-4
Local Programming: A Sample Session . . . . .	2-4
Remote Control Programming . . . . .	2-8
Program Messages . . . . .	2-8
Response Messages . . . . .	2-8
Interface . . . . .	2-9
Status Indicators . . . . .	2-9
Address Displaying . . . . .	2-9
Address Changing . . . . .	2-9
External Input . . . . .	2-10
Channel 1/2 Outputs . . . . .	2-10
Trigger Output . . . . .	2-10

<b>3. Firmware Operation</b>	
Introduction . . . . .	3-1
Power-On . . . . .	3-1
Parser Operation . . . . .	3-2
Synchronization . . . . .	3-2
Error Types . . . . .	3-3
Local Messages . . . . .	3-3
Remote Messages . . . . .	3-4
Polling . . . . .	3-4
Polling: STB Bit 0 Behavior . . . . .	3-4
STB Message . . . . .	3-4
Status Information . . . . .	3-5
STB: Status Byte Register . . . . .	3-7
SRE: Service Request Enable Register . . . . .	3-9
ESR: Standard Event Status Register . . . . .	3-10
ESE: Standard Event Status Enable Register . . . . .	3-11
Input Queue . . . . .	3-12
Output Queue . . . . .	3-12
Error Queue . . . . .	3-12
Key Queue . . . . .	3-13
<b>4. Programming</b>	
Introduction . . . . .	4-1
HP 8112A/60A/61A Message Cross Reference . . . . .	4-1
Interface, Common, and Device Commands . . . . .	4-1
Short Form and Long Form . . . . .	4-2
Coupled Messages . . . . .	4-3
Message Types . . . . .	4-3
Program Message Syntax . . . . .	4-3
Program Message Example . . . . .	4-4
Response Message Syntax . . . . .	4-4
Reading Response Messages . . . . .	4-5
Response Message Example . . . . .	4-5
Syntax Diagram Conventions . . . . .	4-5

<b>5. Local Functions</b>	
Multiple Functions . . . . .	5-1
Display . . . . .	5-2
The :SYSTEM:KEY Command . . . . .	5-2
Specifications . . . . .	5-2
Conflicts . . . . .	5-2
Resolution . . . . .	5-3
Programming of Parameters . . . . .	5-5
1 PULSE . . . . .	5-6
ADS . . . . .	5-7
AMPL . . . . .	5-8
AUTO . . . . .	5-9
BURST . . . . .	5-10
COMP . . . . .	5-11
COUNT . . . . .	5-12
DCYC . . . . .	5-13
DELAY . . . . .	5-15
DISABLE . . . . .	5-16
DOUB . . . . .	5-18
ERROR . . . . .	5-20
E. WIDTH . . . . .	5-22
EXCESSIVE . . . . .	5-24
EXT INPUT . . . . .	5-25
GATE . . . . .	5-27
HIGH . . . . .	5-28
LCL . . . . .	5-29
LEAD . . . . .	5-30
LIMIT . . . . .	5-32
LOW . . . . .	5-33
MAN . . . . .	5-34
MEM . . . . .	5-35
OFFS . . . . .	5-36
OUTPUT . . . . .	5-37
PERIOD . . . . .	5-38
Power-Off/On . . . . .	5-39
RANGE . . . . .	5-40
RCL . . . . .	5-41
RMT . . . . .	5-42

SAVE . . . . .	5-43
SET . . . . .	5-44
Slope . . . . .	5-45
SRQ . . . . .	5-46
THRE . . . . .	5-47
TRA . . . . .	5-48
TRIG . . . . .	5-49
TRIG OUTPUT . . . . .	5-50
Units . . . . .	5-51
VERNIER . . . . .	5-52
WIDTH . . . . .	5-53

**6. Remote Commands, Part I: Common Commands**

*CLS . . . . .	6-2
*ESE . . . . .	6-3
*ESE? . . . . .	6-5
*ESR? . . . . .	6-6
*IDN? . . . . .	6-7
*LRN? . . . . .	6-8
*OPC . . . . .	6-11
*OPC? . . . . .	6-12
*RCL . . . . .	6-13
*RST . . . . .	6-14
*SAV . . . . .	6-16
*SRE . . . . .	6-17
*SRE? . . . . .	6-19
*STB? . . . . .	6-20
*TRG . . . . .	6-21
*TST? . . . . .	6-22
*WAI . . . . .	6-23

**7. Remote Commands, Part II: Device Commands**

:INPut:TRIGger . . . . .	7-6
:INPut:TRIGger:MODE . . . . .	7-7
:INPut:TRIGger:MODE? . . . . .	7-8
:INPut:TRIGger:SLOPe . . . . .	7-9
:INPut:TRIGger:SLOPe? . . . . .	7-9
:INPut:TRIGger:STATe . . . . .	7-10

:INPut:TRIGger:STAtE?	7-11
:INPut:TRIGger:THReshold	7-12
:INPut:TRIGger:THReshold?	7-12
:OUTPut<channel>	7-13
:OUTPut:PULSe	7-14
:OUTPut:PULSe:CSTate	7-14
:OUTPut:PULSe:CSTate?	7-15
:OUTPut:PULSe:POLarity	7-16
:OUTPut:PULSe:POLarity?	7-16
:OUTPut:PULSe:STAtE	7-17
:OUTPut:PULSe:STAtE?	7-17
:PULSe" <channel>	7-18
:PULSe:COUnT	7-18
:PULSe:COUnT	7-19
:PULSe:COUnT?	7-19
:PULSe:EDGE	7-20
:PULSe:EDGE:LEADing	7-20
:PULSe:EDGE:LEADing?	7-21
:PULSe:EDGE:TRAIling	7-22
:PULSe:EDGE:TRAIling?	7-23
:PULSe:LEVel	7-24
:PULSe:LEVel:AMPLitude	7-24
:PULSe:LEVel:AMPLitude?	7-25
:PULSe:LEVel:HIGH	7-26
:PULSe:LEVel:HIGH?	7-26
:PULSe:LEVel:LIMit	7-28
:PULSe:LEVel:LIMit?	7-29
:PULSe:LEVel:LIMit:AMPLitude?	7-29
:PULSe:LEVel:LIMit:HIGH?	7-30
:PULSe:LEVel:LIMit:LOW?	7-30
:PULSe:LEVel:LIMit:OFFSet?	7-31
:PULSe:LEVel:LOW	7-32
PULSe:LEVel:LOW?	7-32
:PULSe:LEVel:OFFSet	7-34
:PULSe:LEVel:OFFSet?	7-34
:PULSe:TIMing"	7-35
:PULSe:TIMing:DELay	7-36
:PULSe:TIMing:DELay?	7-37

:PULSe:TIMing:DOUBle . . . . .	7-38
:PULSe:TIMing:DOUBle? . . . . .	7-39
:PULSe:TIMing:DOUBle:MODE . . . . .	7-39
:PULSe:TIMing:DOUBle:MODE? . . . . .	7-40
:PULSe:TIMing:DutyCYcle . . . . .	7-41
:PULSe:TIMing:DutyCYcle? . . . . .	7-41
:PULSe:TIMing:DutyCYcle:MODE . . . . .	7-42
:PULSe:TIMing:DutyCYcle:MODE? . . . . .	7-43
:PULSe:TIMing:PERiod . . . . .	7-44
:PULSe:TIMing:PERiod? . . . . .	7-45
:PULSe:TIMing:WIDTh . . . . .	7-46
:PULSe:TIMing:WIDTh? . . . . .	7-46
:SYSTem . . . . .	7-47
:SYSTem:DERRor? . . . . .	7-48
:SYSTem:ERRor? . . . . .	7-49
:SYSTem:KEY <code> . . . . .	7-50
:SYSTem:KEY? . . . . .	7-51
:SYSTem:SET <data> . . . . .	7-52
:SYSTem:SET? . . . . .	7-52

**A. Installation and Maintenance**

Safety Considerations . . . . .	A-1
Initial Inspection . . . . .	A-1
Power Requirements . . . . .	A-2
Line Voltage Selection . . . . .	A-3
Power Cable . . . . .	A-4
Operating Environment . . . . .	A-6
Temperature . . . . .	A-6
Humidity . . . . .	A-6
Instrument Cooling . . . . .	A-6
Storage and Shipment . . . . .	A-7
HP-IB Interface . . . . .	A-7
Networks . . . . .	A-7
Cables and Adapters . . . . .	A-7
Connector . . . . .	A-8
Connector Lock Screw Compatibility . . . . .	A-8
Mounting Hardware . . . . .	A-9
Preventative Maintenance . . . . .	A-9



Customer Self Service . . . . .	A-9
HP Service . . . . .	A-9

**B. Specifications**

Specifications . . . . .	B-1
Error Detection . . . . .	B-1
Timing Parameters . . . . .	B-2
Common Specification: Measurement Conditions: . . . . .	B-2
Period . . . . .	B-2
Width . . . . .	B-2
Delay . . . . .	B-3
Double Pulse . . . . .	B-3
Transition Times . . . . .	B-4
Output Levels . . . . .	B-6
Measurement Conditions . . . . .	B-6
High Level . . . . .	B-6
Low Level . . . . .	B-6
Pulse Performance . . . . .	B-6
Operating Characteristics . . . . .	B-7
Timing Parameters . . . . .	B-7
Duty Cycle . . . . .	B-7
Inputs and Outputs . . . . .	B-8
Main Outputs . . . . .	B-8
External Input . . . . .	B-8
Trigger Output . . . . .	B-9
Trigger Modes . . . . .	B-9
Output Capabilities . . . . .	B-11
Limit . . . . .	B-11
Complement . . . . .	B-11
Disable . . . . .	B-11
Set . . . . .	B-11
Additional Features . . . . .	B-11
HP-IB capabilities . . . . .	B-11
HP-IB Interface Code: . . . . .	B-11
Non-Volatile Memory . . . . .	B-11
General Environmental . . . . .	B-12
Storage Temperature . . . . .	B-12

Operating Temperature . . . . .	B-12
Humidity . . . . .	B-12
Power . . . . .	B-12
Weight . . . . .	B-12
Dimensions . . . . .	B-12
Recalibration Period: . . . . .	B-12
<b>C. Performance Tests</b>	
Introduction . . . . .	C-1
Safety . . . . .	C-1
Test Record . . . . .	C-2
Period Test . . . . .	C-3
Specifications . . . . .	C-3
Equipment . . . . .	C-3
Set-Up . . . . .	C-3
Procedure . . . . .	C-4
Delay Test . . . . .	C-6
Specifications . . . . .	C-6
Equipment . . . . .	C-7
Delay Test, Part 1: Short Delay Test . . . . .	C-8
Set-Up . . . . .	C-8
Procedure . . . . .	C-9
Delay Test, Part 2: Long Delay Test . . . . .	C-11
Set-Up . . . . .	C-11
Procedure . . . . .	C-11
Double Pulse Test . . . . .	C-13
Specifications . . . . .	C-13
Equipment . . . . .	C-14
Double Pulse Test, Part 1: Short Double Pulse Test . . . . .	C-15
Set-Up . . . . .	C-15
Procedure . . . . .	C-15
Double Pulse Test, Part 2: Long Double Pulse Test . . . . .	C-17
Set-Up . . . . .	C-17
Procedure . . . . .	C-17
Width Test . . . . .	C-19
Specifications . . . . .	C-19

Equipment . . . . .	C-20
Width Test, Part 1: Short Width Test	C-21
Set-Up . . . . .	C-21
Procedure . . . . .	C-21
Width Test, Part 2: Long Width Tests	C-23
Set-Up . . . . .	C-23
Procedure . . . . .	C-23
Jitter Test . . . . .	C-25
Specifications . . . . .	C-25
Equipment . . . . .	C-25
Jitter Test, Part 1: Period Jitter Test . . . . .	C-26
Set-Up . . . . .	C-26
Procedure . . . . .	C-26
Jitter Test, Part 2: Width Jitter Test . . . . .	C-29
Set-Up . . . . .	C-29
Procedure . . . . .	C-29
Jitter Test, Part 3: Delay Jitter Test . . . . .	C-30
Set-Up . . . . .	C-30
Procedure . . . . .	C-31
High Level and Low Level Tests . . . . .	C-33
Specifications . . . . .	C-33
Equipment . . . . .	C-33
High Level Test . . . . .	C-34
Set-Up . . . . .	C-34
Procedure . . . . .	C-35
Low Level Test . . . . .	C-36
Set-Up . . . . .	C-36
Procedure . . . . .	C-36
Transition Time Test . . . . .	C-37
Specifications . . . . .	C-37
Equipment . . . . .	C-37
Set-Up . . . . .	C-37
Procedure . . . . .	C-38
Pulse Aberration Test . . . . .	C-41
Specifications . . . . .	C-41
Equipment . . . . .	C-41
Set-Up . . . . .	C-41
Procedure . . . . .	C-42

	Performance Test Record . . . . .	C-43	<input type="checkbox"/>
	Recommended Test Equipment . . . . .	C-51	<input type="checkbox"/>
	Feedthrough Termination . . . . .	C-55	<input type="checkbox"/>
<b>D.</b>	<b>Options and Accessories</b>		<input type="checkbox"/>
	Options . . . . .	D-1	<input type="checkbox"/>
<b>E.</b>	<b>Command Cross-References</b>		<input type="checkbox"/>
	Introduction . . . . .	E-1	<input type="checkbox"/>
	HP8112A and HP8130A . . . . .	E-2	<input type="checkbox"/>
	Examples . . . . .	E-5	<input type="checkbox"/>
	HP 8160A, HP8161A and HP8130A . . . . .	E-6	<input type="checkbox"/>
	Examples . . . . .	E-8	<input type="checkbox"/>
<b>F.</b>	<b>Register Bit Assignment</b>		<input type="checkbox"/>
<b>G.</b>	<b>Backdating</b>		<input type="checkbox"/>
	Introduction . . . . .	G-1	<input type="checkbox"/>
<b>H.</b>	<b>Errors</b>		<input type="checkbox"/>
	Power-On Self-Test Errors . . . . .	H-1	<input type="checkbox"/>
	*TST? Errors . . . . .	H-6	<input type="checkbox"/>
	:SYST:ERR? . . . . .	H-9	<input type="checkbox"/>
	:SYST:DERR? . . . . .	H-12	<input type="checkbox"/>
	Conflicts . . . . .	H-15	<input type="checkbox"/>
<b>I.</b>	<b>Sales and Service Office Directory</b>		<input type="checkbox"/>
	Worldwide Sales and Support . . . . .	I-1	<input type="checkbox"/>
	<b>Index</b>		<input type="checkbox"/>

## Figures

---

0-1. Line Voltage Switch Assembly . . . . .	vii
0-2. Power Cables - Plug Identification . . .	viii
3-1. Status Report . . . . .	3-6
3-2. Status Byte Register . . . . .	3-7
3-3. Service Request Enable Register . . . .	3-9
3-4. Event Status Register . . . . .	3-10
3-5. Event Status Enable Register . . . . .	3-11
5-1. Output Voltage Window . . . . .	5-17
5-2. Leading Edge/Trailing Edge Transition Time Relationships . . . . .	5-30
7-1. :INPut:TRIGger Syntax Diagram . . . .	7-6
7-2. :OUTPut:PULSe Syntax Diagram . . . .	7-14
7-3. :PULSe:COUNt Syntax Diagram . . . . .	7-18
7-4. :PULSe:EDGE Syntax Diagram . . . . .	7-20
7-5. :PULSe:LEVel Syntax Diagram . . . . .	7-24
7-6. :PULSe:TIMing Syntax Diagram . . . .	7-35
7-7. :SYSTem Syntax Diagram . . . . .	7-47
A-1. Line Voltage Switch Assembly . . . . .	A-4
A-2. Power Cables - Plug Identification . . .	A-5
A-3. HP-IB Connector . . . . .	A-8
C-1. 50 $\Omega$ , 0.1%, 10W Feedthrough Termination . . . . .	C-55

## Tables

0-1. Line Voltage Ranges . . . . .	v
0-2. Line Voltage and Fuse Selection . . . . .	vi
1-1. . . . .	1-1
5-1. Maximum Values of WIDTH, DCYC and DELAY versus PERIOD . . . . .	5-3
5-2. Maximum Values of DOUB versus PERIOD . . . . .	5-3
5-3. Period, Delay, Double, Width and Transition Time Ranges . . . . .	5-4
5-4. Units . . . . .	5-51
6-1. Common Command Summary . . . . .	6-1
6-2. PULSE *LRN? . . . . .	6-8
6-3. Reset State (Standard Setting) . . . . .	6-15
7-1. :INPut Command List . . . . .	7-1
7-2. :OUTPut Command List . . . . .	7-2
7-3. :PULSe Command List . . . . .	7-3
7-4. :SYSTem Command List . . . . .	7-5
7-5. :SYSTem:KEY Codes . . . . .	7-50
A-1. Line Voltage Ranges . . . . .	A-2
A-2. Line Voltage and Fuse Selection . . . . .	A-3
B-1. Maximum Values of WIDTH, DCYC, and DELAY versus PERIOD . . . . .	B-1
B-2. Maximum Values of DOUB versus PERIOD . . . . .	B-2
C-1. . . . .	C-51
E-1. HP 8112A and HP 8130A . . . . .	E-2
E-2. HP 8160A/61A and HP 8130A . . . . .	E-6
F-1. . . . .	F-1
H-1. Power-On Self-Test Errors . . . . .	H-1
H-2. :SYSTem:ERRor? Error Messages . . . . .	H-9

H-3. :SYSTEM:DERRor? Error Messages . .	H-12
H-4. Conflict Error Message . . . . .	H-15





## General

---

### Introduction

The HP 8130A is a 300 MHz pulse generator providing simultaneous normal and complement output signals from 100 mVpp to 5.00Vpp.

The standard instrument contains one channel; a two channel instrument is also available. A second channel cannot be fitted to an existing instrument.

For the specifications of this instrument see Appendix B.

For a list of the options and accessories available see Appendix D.

---

### Instrument Features

Table 1-1.

Input	Signal Output	Trigger Output
External Input	State	
Manual	Polarity	
Single Pulse		
Polarity		
Threshold		



## Pulse Generator Definitions

The following are definitions for some of the terms used in connection with this instrument.

- Time Reference Point** Median (50% amplitude point on pulse edge).
- Pulse Period** The time interval between the leading edge medians of consecutive trigger output pulses.
- Trigger Delay** Interval between trigger point of input signal and the trigger output pulse's leading edge median. Applies in trigger, external width, and burst modes.

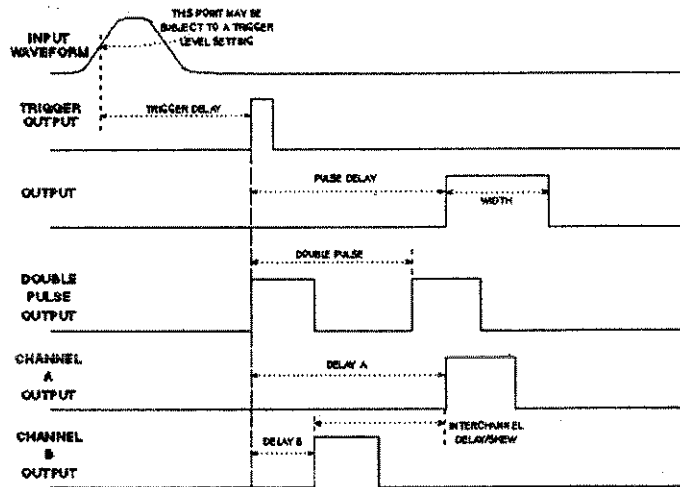

### Pulse Generator Definitions

**Pulse Delay** Interval between leading edge medians of trigger output pulse and output pulse.

**Double Pulse** Interval between leading edge medians of the double pulse.

### Interchannel Delay/Skew

Interval between corresponding leading edge medians.

**Delay** The specified and displayed value is that obtained with the fastest leading edge. For a slower edge, the actual delay exceeds the displayed delay by the combined shift of start point and median.

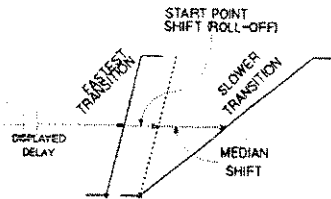

## Pulse Generator Definitions

**Pulse Width** Interval between corresponding leading- and trailing-edge medians. The specified and displayed value is that obtained with fastest edges; essentially equal to the interval from the start of the leading edge to the start of the trailing edge.

By designing so that the pulse edges turn about their start points, the interval from leading edge start to trailing edge start stays unchanged† when transition times are varied. This is more convenient for programming and the width display is easy to interpret.

†In practice, start points may shift with changes in transition time.

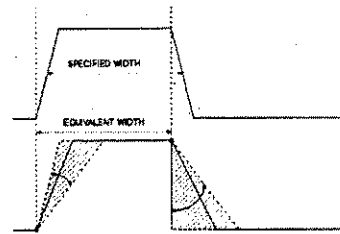

**Transition Time** Interval between the 10%- and 90%- amplitude points on the leading/trailing edge.

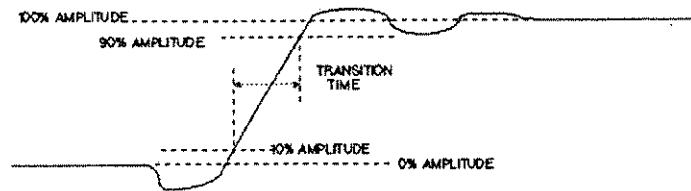

## Pulse Generator Definitions

**Linearity** Peak deviation of an edge from a straight line through the 10%- and 90%- amplitude points, expressed as percentage of pulse amplitude.

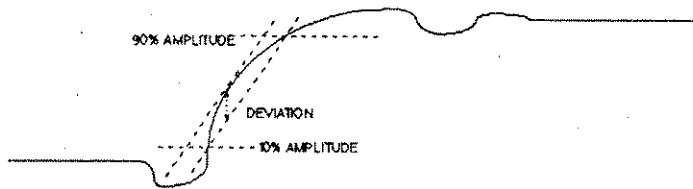

**Jitter** Short term instability of one event with respect to another. rms jitter is based on 1000 measurements and is identical to the standard deviation

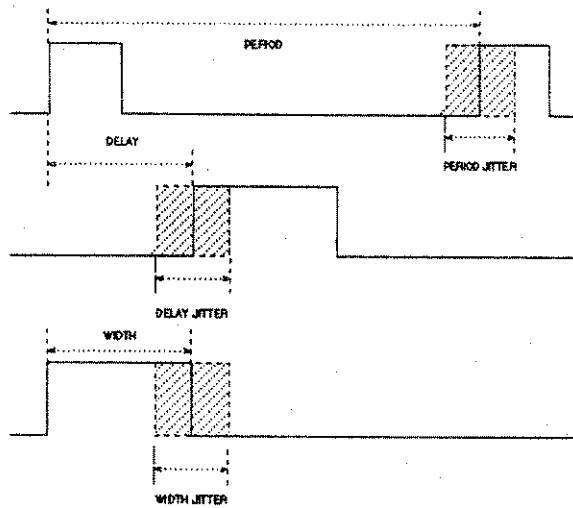

## Pulse Generator Definitions

**Stability** Long term average instability expressed as percentage of main parameter over a specific time duration, e.g. hour, year. Excludes jitter.

**Pulse Level** High level and low level. Any limitation is expressed by an amplitude specification.

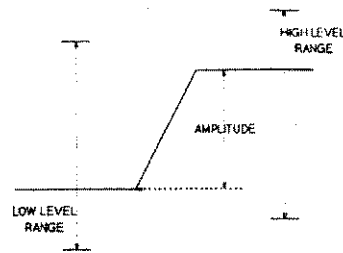

**Pulse Amplitude** (alternative to level definition)  
Pulse amplitude and baseline offset are specified. Any limitation is expressed by a window (max high level, min low level).

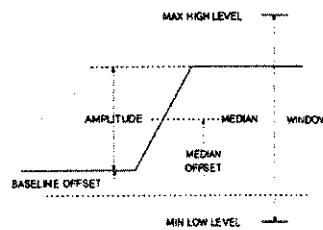

## Pulse Generator Definitions

### Preshoot, Overshoot, Ringing

Preshoot and overshoot are peak distortions preceding/following an edge. Ringing is the positive peak and negative peak distortion excluding overshoot, on pulse top or base. A combined specification of e.g. 10% implies:

- Overshoot/undershoot <10%
- Largest pulse-top oscillation <±10% of pulse amplitude.

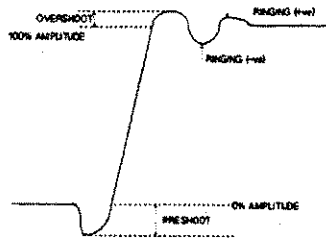

### Settling Time

Time taken for pulse levels to settle within level specification, measured from 90% point on leading edge.

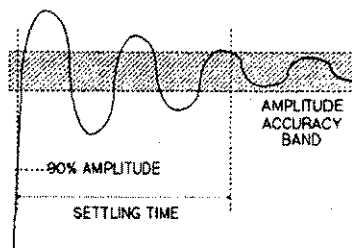



## Pulse Generator Definitions

**Duty Cycle** Percentage ratio of pulse width to period. In pulse/function generators this term is also used to define sine and triangle symmetry.



### Output Impedance/Resistance:

Effective pulse source impedance/dc resistance.

**Reflection Coefficient** Reflection at a pulse generator output expressed in percent of incident pulse amplitude. (Test pulse edges correspond to generator's fastest transitions).

**Repeatability** When an instrument operates under the same environmental condition, and with the same settings, the value of a parameter will lie within a band inside the accuracy window. Repeatability defines the width of this band.

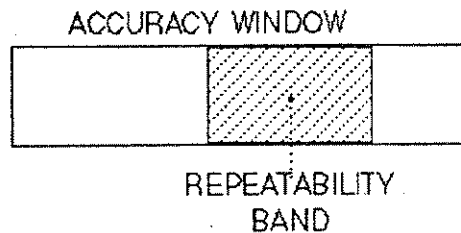

---

## HP-IB Programming Times

- Listen Time**      The time an instrument occupies the bus to receive and verify a message. The NRFD signal is active during this period.
- Settling Time**      The time taken by the instrument to execute an HP-IB message, and for the output to settle within the accuracy specification.  
NRFD inactive.
- Execution Time**      The sum of Listen Time and Settling Time
- Talk Time**      The time an instrument occupies the bus to output a specified string. Output data is typically instrument error status, or current or stored parameters.

## Operation

---

### Power-On

At power-on, the instrument performs a self-test. After a successful self-test it enters the normal operating state. If there is a problem an error condition is reported. This is indicated by an error number on the instrument display, or in the status byte if the instrument is being controlled over the HP-IB.

### Power-On Self-Test

The instrument performs the following tests during the power-on self-test sequence:

1. Processor board tests
2. Parametric board Tests

During the self-test all of the LEDs light and the display shows 8.8.8.8. If any of the LEDs or display segments do not light during the power-on self-test this indicates a possible problem on the display board.

See Table H-1 for the scope of the power-on self-test.

### Normal State

When the instrument enters the normal operating state it is set up as follows:

- The instrument is initialized and enters the idle state.
- The setting is set to one of the following:
  - To the setting stored at power-off, however, the outputs are disabled. The power-off address is restored.

- To the standard setting if the internal memory data is invalid. The instrument's address is set to 11, the default address.

### Power-On Error Condition

If an operating-error exists there are two possible causes. These are listed here:

- Processor board test failure: In this case the instrument *can not be operated*. The error condition code is reported at the instrument's display in the format Fnnn. See Table H-1 for a list of the Fnnn type errors.
- Parametric board test failure: In this case the instrument *is operable*, however, *parametric capability is restricted*. The error condition code is reported at the instrument's display in the format Ennn. See Table H-1 for a list of the Ennn type errors.

---

### Power-Off

At power-off, the instrument's setting and interface address are stored in battery supported internal memory.

---

### Instrument Setting

The instrument setting contains the complete operating state of the instrument.

The setting can also be stored in or recalled from internal memory. The internal memory is battery supported and will retain it's contents after the power is switched off. Up to 19 settings can be stored.

---

## Programming of Parameters

Period, width, double, and transition under-programming are allowed. This is to ensure that the specified minimum values can always be obtained. See Chapter 5 and Chapter 7.

Low and high levels can be under-programmed or over-programmed to ensure that the specified minimum and maximum values can always be obtained.

---

## Local Programming

In the local programming mode, the instrument is controlled by using the keys on the front panel.

The front panel controls and functions are described in Chapter 5.

## Function Selection and Data Entry

The instrument can be controlled from the front panel. Keys are provided so that any of the operating parameters can be checked or altered. LEDs are used to indicate which parameter is currently selected. The value of the current parameter is displayed.

To select one of the functions on the front panel, press the corresponding key. An LED lights to indicate the selection that has been made. In some cases a key will be used for more than one function, you should press the key repeatedly until the LED for the parameter you want to use is lit.

If the value for the current parameter is to be changed, use the up or down vernier keys or the range keys to make the changes.

## Device Errors

Some combinations of parameter values are not possible. When there is conflict between the values of two parameters the **ERROR** message lights and the LEDs for each of the conflicting parameters blink. For a description of the relationships between parameters that cause conflicts, see Chapter 5.

The leading and trailing edges of the pulse and the pulse width and period are all programmable. It is possible to program these so that the pulse cannot reach full amplitude, when this occurs **EXCESSIVE LED** lights to warn you.

If the limiting condition is important in the application, the output should be verified on an oscilloscope. In other cases, the timing should be adjusted until the error display turns off, indicating that the outputs are valid.

## Local Programming: A Sample Session

In this short session we will set up a dual channel instrument with a single pulse in one channel and a double pulse in the other. The single pulse is delayed, with respect to the double pulse, by  $17.5\mu s$ . The pulses have the characteristics given in the following table.



	Pulse 1	Pulse 2
Period	850 $\mu$ s	850 $\mu$ s
Delay	17.5 $\mu$ s	—
2nd Pulse Delay	—	300 $\mu$ s
Width	15.5 $\mu$ s	—
Duty Cycle	—	25%
Transition Time:		
Leading Edge	1.00 $\mu$ s	40 $\mu$ s
Trailing Edge	2.75 $\mu$ s	25 $\mu$ s
High Level	3.00V	—
Low Level	-2.00V	—
Amplitude	—	4.30V
Offset	—	-0.12V

When the instrument is set, we will then save this setup into the internal memory.

To set up the instrument you should use the following procedure.

**Note**



Some keys have more than one function. An LED lights, above the key, beside the current function. The name given to a key, in the description below, is the current function of that key.

**Note**



If you have a single channel instrument, you will have to implement the two waveforms separately.

1. Switch the instrument on. Check, during the self-test that all LEDs and display segments are lighting.
2. First we want to restore the default settings of the instrument. To do this you should
  - a. Press .
  - b. Use the up or down VERNIER arrow keys to select memory 0. Memory zero is selected when 0 is shown on the display.
  - c. Press to recall this setup from memory.
3. The LED in the key is lit and the display shows the current period, which is 1.00 ms. Press the left most VERNIER  $\downarrow$  twice and the middle VERNIER  $\uparrow$  5 times. These set the value of the left most digit and the middle digit on the display respectively. The display shows the period is now 850  $\mu$ s.

This completes the setup common to both channels. We will now continue with the setup for channel 1. All of the keys referred to in the next section are for channel 1.

4. Press the key. The LED in the key lights and the display shows the current delay (which is 0ps). Press the left VERNIER  $\uparrow$  key once. Press the RANGE  $\uparrow$  key 5 times, so that our setting will be in 10.0s of microseconds. Press the middle VERNIER  $\uparrow$  key 7 times, and the right VERNIER  $\uparrow$  key five times. The variable pulse delay is now set to 17.5 $\mu$ s (as shown on the display).
5. Press the key, and use the VERNIER and RANGE keys to set the width of the pulse to 15.5 $\mu$ s.
6. Press the key and use the VERNIER keys to set the trailing edge transition time to 2.75 $\mu$ s
7. Press the key and use the VERNIER keys to set the high level of the signal to 3.00V.



8. Press the key and use the VERNIER keys to set the low level of the signal to -2.00V.

The delayed single pulse is now setup in the first channel. The following instructions cover the configuration of the second channel. All of the keys referred to in the next section are for channel 2. If you are using a single channel instrument you can use these instructions with keys in channel 1, but these settings will replace any that you have already made.

9. Press the key twice. We can now set the duty cycle of the pulse. Use the VERNIER keys to set the duty cycle to 25%.
10. Press the key twice. We have now enabled the double pulse and can set the delay between the two pulses. Use the VERNIER keys to set the delay to  $300\mu\text{s}$ .
11. Press the key. Press the RANGE  $\uparrow$  key once so that we are setting the leading edge transition time in 10.0s of microseconds. Use the VERNIER keys to set the leading edge time to  $40\mu\text{s}$ .
12. Press the key. Use the VERNIER keys to set the trailing edge transition time to  $25\mu\text{s}$ .
13. Press the key twice. We can now set the amplitude of the pulse. Use the VERNIER keys to set the amplitude to 4.30V
14. Press the key. Use the VERNIER keys to set the signal offset to -0.12V.

This ends the setting of the parameters for the double pulse signal.

To enable the signals, and to save them to memory use the following procedure.

15. To save the setup to memory
  - a. Press .

- b. Use the up or down VERNIER arrow keys to select empty memory location. You cannot save to memory location 0.
  - c. Press to store this setup to memory.
16. To enable the signal from channel 1, press the key above the OUTPUT or the OUTPUT.
  17. To enable the signal from channel 2, press the key above the OUTPUT or the OUTPUT.

---

## Remote Control Programming

The instrument can be programmed from a remote controller by using the Hewlett-Packard Interface Bus (HP-IB). Program messages can be sent to the instrument and the instrument can return test, operating state, parameter, and identification information in response messages.

### Program Messages

Information on program messages is to be found in Chapter 4, details on individual commands are to be found in Chapter 6, which covers commands common to all machines using the language specified, and Chapter 7, which covers commands specific to this instrument.

### Response Messages

Information on response messages is to be found in Chapter 4, details on individual responses are to be found in Chapter 6, which covers responses to common commands, Chapter 7, which covers the responses to device commands, and Appendix H, which covers the error messages.

---

## Interface

The interface, HP-IB, is a byte-serial, bit-parallel, asynchronous, digital interface.

The interface port is located on the rear panel.

## Status Indicators

The following three indicators on the front panel show interface status.

- RMT (remote) indicates when the instrument is in the remote programming mode.
- ADS (address) indicates when the instrument is listen or talk addressed.
- SRQ (service request) indicates when a service request is pending; the interface SRQ control line is asserted.

## Address Displaying

The instrument address can be read on the front panel display by pressing the LCL (local) key while in the local programming mode. The result is displayed as A followed by the address, for example A 10 would indicate that the instrument has the address 10.

## Address Changing

To change the address (local programming mode only):

- Press the LCL key.
- Change the address in the display by using the vernier keys.
- Press the LCL key again.

The address cannot be changed if the instrument is talk or listen addressed, if a service request is pending or when the instrument is in the remote programming mode.

---

## External Input

External input (marked EXT INPUT on the instrument) is the signal input for use in the trigger, gate, burst, or external width operating modes. The operating modes are described in Chapter 5.

---

## Channel 1/2 Outputs

Each channel has two differential outputs (marked OUTPUT and  $\overline{\text{OUTPUT}}$  on the instrument). The standard instrument has one channel. Channel 2 is an optional second channel, specified at the time of ordering the instrument.

### Note



---

It is not possible to fit the second channel to an existing, single-channel instrument.

---

---

## Trigger Output

Trigger output (marked TRIG OUTPUT on the instrument) is the reference signal for the channel 1 and 2 output waveforms.



## Firmware Operation

---

### Introduction

This chapter describes various features of the normal operation of the instrument. These include the power-on procedure, the operation of the parser, and structures used for the status data.

---

### Power-On

At power-on, the instrument goes through the following procedure:

1. The instrument initializes itself:
  - a. The input queue is cleared.
  - b. The output queue is cleared.
  - c. The front panel key queue is cleared.
  - d. STB, SRE, ESR, and ESE registers, and the error queue are cleared.
  - e. The parser is reset.
  - f. The execution control is reset.
  - g. The response formatter is reset.
2. The instrument then enters the idle state awaiting a command.
3. The setting at power-off is restored as the current setting; however, the outputs are disabled.
4. The power-off address is also restored.

**Note**



If the RAM data is invalid, the power-off setting cannot be restored. In this case, the standard setting and the default address, 11, are restored.

**Parser Operation**

The parser is a program which runs on the HP8130A monitoring the HP-IB interface. It is responsible for reading in messages from the interface, converting them into commands, and then performing those commands on the instrument.

Normally, the instrument removes all incoming data from the interface port and places it in the input queue. When all the data has been received and placed in the queue it is parsed.

When the input queue is full, and there are additional bytes at the interface the parser removes one byte at a time from the input queue and parses it, then a byte is taken from the interface port and added to the input queue. If there are still more bytes at the interface, the process, of parsing one byte and then getting a byte from the port and putting it in the queue, continues until the input port all bytes are input. When all of the bytes have been received the entire input queue is parsed in the normal way.

**Synchronization**

All commands are executed sequentially, that is one after the other.

If \*OPC or \*OPC? is parsed, a delay of two seconds occurs before the OPC bit is set or an ASCII coded '1' is placed in the output queue. See Chapter 6.

If \*WAI is parsed, a delay of two seconds occurs before executing any other commands. See Chapter 6.



At the end of two seconds, all operations are complete.

---

## Error Types

There are four categories of instrument errors. A full list of errors is to be found in Appendix H

- Power-on self-test errors identify microprocessor and output board failures occurring at power-on. See Table H-1 for the extent of the test.
- Self-test (\*TST?) errors identify output board failures. The test is identical to the output board test performed at power-on. See Table H-2
- Command, execution, device dependent, and query error events are reported in the standard event status register (ESR). These errors can be read in response to the :SYST:ERR? query. See Table H-3
- Device dependent error conditions are reported in bit 0 of the status byte register. These errors can be read in response to the :SYST:DERR? query. See Table H-4 and Table H-5

The device dependent errors are reported on the front panel by blinking LEDs and are referred to as conflicts in the manual.

## Local Messages

Power-on error messages are displayed immediately after the failure of one of the power-on self-tests. See Table H-1 for a list of messages.

There are two types:

- Processor board test failure: the instrument *can not be operated*.

The error condition code is reported at the instrument's display in the format Fnnn.

- Parametric board test failure: the instrument is operable, however, parametric capability is restricted.

The error condition code is reported at the instrument's display in the format Ennn.

### Remote Messages

Remote error messages can be read in response to the following queries:

- `*TST?` (See Table H-2).
- `:ERR?` (See Table H-3)
- `:DERR?` (See Table H-4)

### Polling

The instrument's interface is of the type T6 (according to the *IEEE Standard 488*). This means that the serial poll method of requesting service is used.

#### Polling: STB Bit 0 Behavior

Bit 0 of the status byte register always reflects the actual state of the device. If a conflict is present, Bit 0 will be set. If all conflicts are cleared, Bit 0 will also be reset.

If Bit 0 is set (1) a service request is generated, providing that there is no currently pending service request.

**STB Message.** The status can be read from bits 7 and 5 to 0 of the status byte register.





Bit 7: not used

Bit 5: ESB (Event Status Bit)

Bit 4: MAV (Message Available)

Bit 3: not used

Bit 2: not used

Bit 1: not used

Bit 0: H (hardware error summary-condition-bit)

The errors causing bit 0 to be set are reported in response to a :DERR? query: See Table H-4 for a listing of the :SYST:DERR? query errors.

---

## Status Information

There are four registers involved in the status information available from the instrument. Two of these are status registers and two are enable registers. These registers conform to the *IEEE Standard 488.2-1987*.

The registers are related as indicated in the following figure.

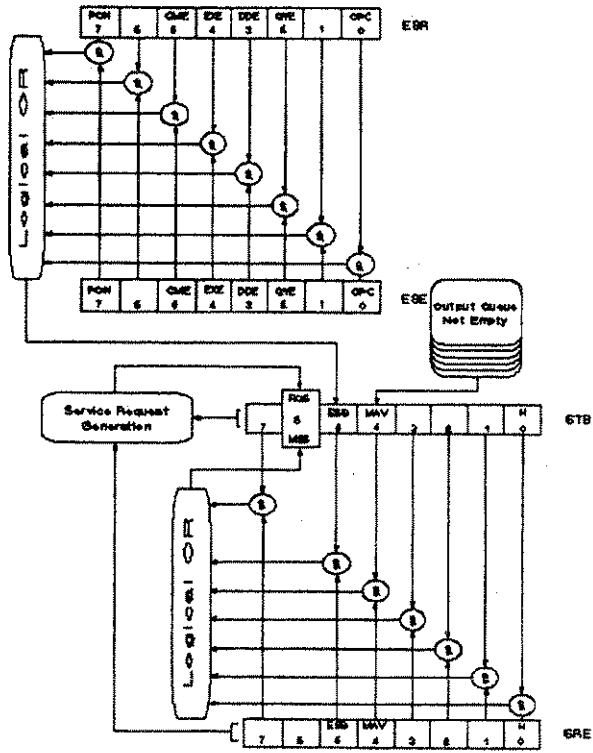

Figure 3-1. Status Report

3-6 Firmware Operation

## STB: Status Byte Register

**Description** The status byte register (STB) is described in the following figure.

The Master Summary Status (MSS) bit is true when any enabled bit of the STB register is set (excluding Bit 6).

[Bit 7][Bit 6][Bit 5][Bit 4][Bit 3][Bit 2][Bit 1][Bit 0]

Bit 7: Not used, value = 0

Bit 6: RQS / MSS (Request Service / Master Summary Status)

Bit 5: ESB (Event Status Bit)

Bit 4: MAV (Message Available)

Bit 3: Not used, value = 0

Bit 2: Not used, value = 0

Bit 1: Not used, value = 0

Bit 0: H (Hardware error summary-condition-bit)

**Figure 3-2. Status Byte Register**

**Note**



MSS is found in bit 6 when the register is read by an \*STB query, RQS is found in bit 6 when the register is read by a serial poll.

**Reading**

There are two ways of reading the status byte register:

- An \*STB? query.
- A serial poll.

**STB: Status Byte Register**

The status byte including, the master summary bit, MSS, is not directly altered as a result of an \*STB? query.

**Note**



MSS can be indirectly altered by the query when MAV is enabled.

The request for service, RQS, bit is cleared, but otherwise the status byte, including the MSS bit, are not altered as a result of a serial poll.



---

## SRE: Service Request Enable Register

**Description** The service request enable register (SRE) allows enabling of status byte register (STB) bits. See “\*SRE” in Chapter 6 command. A bit must be set in this register to enable the corresponding bit in the STB register to effect the MSS or RQS bits.

Bit six of the status byte register cannot be disabled. Even if an \*SRE message tries to disable bit six, it remains operational.

[Bit 7][Bit 6][Bit 5][Bit 4][Bit 3][Bit 2][Bit 1][Bit 0]

Bit 7: Not used, value = 0

Bit 6: Not used, value = 0

Bit 5: ESB (Event Status Byte)

Bit 4: MAV (Message Available)

Bit 3: Not used, value = 0

Bit 2: Not used, value = 0

Bit 1: Not used, value = 0

Bit 0: H (Hardware error summary-condition-bit)

**Figure 3-3. Service Request Enable Register**

**Reading** The service request enable register (SRE) is non-destructively read with the \*SRE? query.

---

## ESR: Standard Event Status Register

**Description** The standard event status register (ESR) is described in the following figure.

[Bit 7][Bit 6][Bit 5][Bit 4][Bit 3][Bit 2][Bit 1][Bit 0]

Bit 7: PON, Power-on

Bit 6: Not used, value = 0

Bit 5: CME, Command Error

Bit 4: EXE, Execution Error

Bit 3: DDE, Device Dependent Error

Bit 2: QYE, Query Error

Bit 1: Not used, value = 0

Bit 0: OPC, Operation Complete

**Figure 3-4. Event Status Register**

**Reading** The standard events status register is read with the \*ESR? query.

The register is cleared after being read.

Additional information on CME, EXE, DDE, and QYE status is obtained with the :SYST:ERR? query. See Chapter 7 and Table H-3.

---

## ESE: Standard Event Status Enable Register

**Description** The standard events status enable register, (ESE), described in the following figure, enables bits of the standard events status register, ESR. A bit must be set in this register to enable the corresponding bit in the events status register.

The register is masked with the \*ESE command and cleared with an \*ESE 0 message.

[Bit 7][Bit 6][Bit 5][Bit 4][Bit 3][Bit 2][Bit 1][Bit 0]

Bit 7: PON, Power-on

Bit 6: Not used, value = 0

Bit 5: CME, Command Error

Bit 4: EXE, Execution error

Bit 3: DDE, Device Dependent Error

Bit 2: QYE, Query Error

Bit 1: Not used, value = 0

Bit 0: OPC, Operation Complete

**Figure 3-5. Event Status Enable Register**

**Reading** The standard event status enable (ESE) register is non-destructively read with the \*ESE? query.

---

## Input Queue

The input queue is:

- FIFO queue (first-in first-out)
- 100 bytes long.

---

## Output Queue

The output queue is:

- FIFO queue (first-in first-out)
- 40 response messages long

The message available, MAV, bit is set in bit four of the status byte when the output queue contains a message.

The output queue and the MAV bit are cleared directly after the program message terminator when a new program message is received.

---

## Error Queue

The error queue is a:

- FIFO queue (first-in first-out)
- 10 errors long

If the queue overflows, message '-350 <too many errors>' overlays the last message in the queue.





---

## Key Queue

The key queue records real key presses, not `:SYST:KEY` simulated key presses.

The key queue is a:

- FIFO queue (first-in first-out)
- 1 key long

If the queue is empty, message '0' is returned in response to the `:SYST:KEY?` query.

The key queue is cleared after power-on or `*RST`.



## Programming

---

### Introduction

The messages and commands used when programming the HP 8130A from a remote controller are described in this chapter.

---

### HP 8112A/60A/61A Message Cross Reference

The language used by the HP 8130A is based on *IEEE Standard 488.2-1987* and is different from the languages used in the HP 8112A, HP 8160A, and HP 8161A. It is the same as the language used in the HP 8131A.

To assist in converting programs from one language to the other, Appendix E contains cross referenced examples of the HP 8112A/60A/61A and HP 8130A instrument messages.

---

### Interface, Common, and Device Commands

Interface commands are defined in the *IEEE Standard 488.2-1987*. These messages are processed by the interface system directly, they are used to manage the interface. These messages are not described in this manual, though reference is made to them where appropriate.

The remote messages which are described are the messages that are carried by the interface system, but which are not used by it or processed by it. These are described in Chapter 6 and Chapter 7.

Common commands (described in Chapter 6) are a reserved group of commands, which are defined by the *IEEE Standard 488.2-1987*. Common commands can apply to any instrument using this standard.

The device commands which are described in this manual (see Chapter 7) are commands defined specifically for use with this instrument.

---

## Short Form and Long Form

The instrument will accept messages in short or long forms. The short form messages must be all in upper case. Long form messages can be all in upper case or in a mixture of upper and lower case. Where you are using mixed upper and lower case, only the characters not used in the corresponding short form can be in lower case, for example:

the short form message `:INP:TRIG:STAT ON`  
can be written as `:INPut:TRIGger:STATe ON`  
or as `:INPUT:TRIGGER:STATE ON` in the long form.

In this manual the messages are written in a combination of upper and lower case, the upper case characters are used for the short form parts of the message.

---

## Coupled Messages

The following messages are related, :PULSe:LEVel:HIGH, :PULSe:LEVel:LOW, :PULSe:LEVel:AMPLitude, and :PULSe:LEVel:OFFSet. This means that using one of these messages to change a value can affect values set by the other messages.

The relationships of the coupled messages are given in Chapter 5.

---

## Message Types

Two types of messages are used.

1. Program messages which are sent from a remote controller to the HP 8130A.
2. Response messages which are sent from the HP 8130A to the controller.

## Program Message Syntax

A program message is of the form <ASCII-string><pmt>.

- <ASCII-string> is one or more program message units. Message units are separated by a semi-colon (;).

Each path in the syntax diagrams of Chapter 6 and Chapter 7 represents a complete program message unit

- <pmt> is the program message terminator. There are three possible terminators
  - <lf>, the line feed character.
  - <^END>, the EOI line on the HP-IB being asserted.
  - <lf><^END>

**Note**



---

<lf> is equivalent to newline.

---

''' means the END is asserted at the last byte of the program message on the interface bus by asserting the End or Identify (EOI) signal line.

**Program Message Example**

```
OUTPUT 711;  "*"RST;  
:PULSe:TIMing:DELay 20 ns;  
WIDT 200µs;  
:PULSe:LEVel:HIGH 3.5V;  
LOW 1"
```

**Response Message Syntax**

A response messages is of the form <ASCII-string><rmt>.

- <ASCII-string> is one or more response message units.

The message units are defined in Chapter 6 and Chapter 7.

- <rmt> is the response message terminator.  
<lf><^END> is the only terminator used by the instrument. <lf>, the line feed character. <^END>, the EOI line on the HP-IB being asserted. ''' means the END is asserted at the last byte of the program message on the interface bus by asserting the End or Identify (EOI) signal line.

**Note**



---

<lf> is equivalent to newline.

---

Only values are returned in responses messages; the base units are implied.



See Chapter 6 and Chapter 7 for examples.

### Reading Response Messages

If you perform a query, you must read the response before you send the next program message. The response is deleted from the output queue by the instrument while it is processing the next message.

### Response Message Example

```
OUTPUT 711; "*RST"  
OUTPUT 711; ":PULSe:LEVe1:HIGH?"  
ENTER 711; A$  
PRINT A$ -----> 0.50
```

---

## Syntax Diagram Conventions

< ... >	The characters between the angled brackets indicate the kind of data that is required. The angled brackets are not typed in the actual message.
wsp	is used to indicate white spaces, this group includes ASCII control characters and the space but it excludes the newline character.
value	is used to indicate values in integer (12), decimal (85.5), or exponential format (99.9E-9).

**unit** is used to indicated one of s/S (seconds), v/V (volts) % (percent) or one of ps/PS, ns/NS,  $\mu$ s/US, ms/MS, uv/UV, mv/MV

[ ... ] the characters between the square brackets indicates optional information that can be included with the message.

| is used to indicate an either-or choice of data, for example a|b indicates either a or b, but not both at the same time

**MIN** When used in a program message **MIN** sets up the minimum value allowed for that parameter.

When used in a query message **MIN** returns the minimum value allowed for that parameter.

**MAX** When used in a program message **MAX** sets up the maximum value allowed for that parameter.

When used in a query message **MAX** returns the maximum value allowed for that parameter.

All terms not defined above should be input as given. Short and long forms are allowed.



## Local Functions

---

Local functions are functions which are available from the front panel keys. They are described here alphabetically using the name given on the front panel. Each key is described and a list of the equivalent and related remote programming commands are given.

Descriptions of the front panel status LEDs are also given.

---

### Multiple Functions

Where a key is used to activate more than one function, the functions are described separately, for example both DCYC and WIDTH are activated by the same key, but they are described separately. When selecting these functions the key should be pressed repeatedly until the LED beside the desired function is lit.

#### Note



---

The positive and negative slope keys (located on the front panel above the EXT INPUT) are treated together under the heading *Slope*.

---

---

## Display

Where a key allows access to one of the parameters, the current value of the parameter is shown on the display. The value can be changed by using the VERNIER keys, see "VERNIER."

---

## The :SYSTem:KEY Command

Each of the front panel keys has a related :SYSTem:KEY Command. This has not been listed under the *Remote Commands* heading. A full list of the SYSTem:KEY Commands is given in Table 7-5

---

## Specifications

All specifications apply after a 30 minute warm-up period with 50 $\Omega$  load resistance at all outputs and are valid at ambient temperatures in the range 0°C to 55°C.

---

## Conflicts

An error display indicates that a programmed setting exceeds the specification, and that the output may be invalid. If the limiting condition is important in the application, the output should be verified on an oscilloscope. In other cases, the timing should be adjusted until the error display turns off, indicating that all outputs are valid. The table below gives values versus period above which an error will be indicated.

**Table 5-1.**  
**Maximum Values of WIDTH, DCYC and DELAY**  
**versus PERIOD**

PERIOD(ns)	On-Time	DELAY
3.33 ... 4.99	$0.5 \times \text{PERIOD}$	$0.5 \times \text{PERIOD} - 1\text{ns}$
5.00 ... 19.9	$0.7 \times \text{PERIOD} - 1\text{ns}$	$0.7 \times \text{PERIOD} - 2\text{ns}$
$\geq 20.0$	$0.9 \times \text{PERIOD} - 5\text{ns}$	$0.9 \times \text{PERIOD} - 6\text{ns}$

**Note**



On-Time in this table refers to the value set by DCYC (duty cycle) as well as by WIDTH.

**Table 5-2.**  
**Maximum Values of DOUB versus PERIOD**

PERIOD(ns)	DOUB
3.33 ... 7.19	n/a
7.20 ... 9.99	$0.5 \times \text{PERIOD}$
$\geq 10.0$	$0.9 \times \text{PERIOD} - 4\text{ns}$

**Resolution**

The resolution of some of the timing parameters depends on the period of the signal. These relationships are outlined in the table below.

**Table 5-3.  
Period, Delay, Double, Width and Transition  
Time Ranges**

<b>Range</b>	<b>Resolution</b>
† - 9.99ns	0.01ns
10.0ns - 99.9ns	0.1ns
100ns - 999ns	1ns
1.00μs - 9.99μs	0.01μs
10.0μs - 99.9μs	0.1μs
‡100μs - 999μs	1μs
‡1.00ms - 9.99ms	0.01ms
‡10.0ms - 99.9ms	0.1ms
† Period:	3.33ns
Delay:	0.00ns
Double:	3.33ns
Transition	
Times:	1.00ns
Width:	1.50ns

‡ does not apply to transition times

**5-4 Local Functions**

---

## Programming of Parameters

Period, width, double, and transitions are under-programmable to ensure that the specified minimum values can always be obtained.

Low and high levels can be under- or over- programmed so that the specified minimum and maximum values can always be obtained.

The minimum and maximum programmable values are displayed in each section with the sign  $\leq$ . The specified minimum and maximum are given after the *Specified Range* heading.

---

## 1 PULSE

<b>Description</b>	One pulse or double-pulse is generated for each press of this key when the instrument is in trigger, gate, or burst operating mode.
<b>Remote Commands</b>	None.
<b>Related Keys</b>	MAN, EXT INPUT, TRIG, GATE, BURST
<b>Interface Commands</b>	None.

---

**ADS**

**Description** The ADS indicator (lighted LED) indicates when the instrument is listen or talk addressed.

The interface address cannot be changed when the instrument is listen or talk addressed.

**Remote Commands** None.

**Related Keys** RMT, SRQ, LCL

**Interface Commands** MLA, MTA, UNL, UNT.

---

## AMPL

**Description** This key is used to program the amplitude of the output waveform. It is used in together with the OFFS key to set the upper and lower levels of the output signal. The amplitude can be in the range 0.10V to 5.00V. The amplitude can be varied in steps of 0.01V. The default value is 0.10V

$$0.10V \leq \text{Amplitude} \leq 5.00V$$

Resolution: 0.01V

Default: 0.10V

The amplitude, offset, high level, and low level parameters are coupled. To alternate between the HIGH and LOW, and AMPL and OFFS settings you should press the HIGH or LOW buttons repeatedly until the pair of LEDs for the functions you require are lighting.

Amplitude is equivalent to the difference between the high level and the low level.

Amplitude  $\equiv$  High-Low

Overvoltage disabling: See "DISABLE."

**Remote Commands** :PULSe:LEVel:AMPLitude <value>|MIN|MAX

**Related Keys** HIGH, LOW, OFFS

**Interface Commands** None.



---

**AUTO**

**Description** The AUTO LED indicates that the automatic operating mode has been selected.

**Automatic Operating Mode:**

A continuous waveform (free run mode) is generated.

Select the automatic operating mode by pressing the mode select key. The AUTO LED lights when the automatic operating mode is active.

The mode is common to channels 1 and 2 in dual channel instruments, it cannot be set individually for each channel.

The external input is disabled when the automatic operating mode is active.

**Remote Commands** :INPut:TRIGger:MODE AUTO

**Related Keys** TRIG, GATE, BURST, E.WIDTH

**Interface Commands** None.

---

## BURST

<b>Description</b>	<p>The BURST LED indicates that the burst operating mode has been selected.</p> <p><b>Burst Operating Mode:</b> A specified number of pulses or double-pulses (1-9999) are generated for each burst trigger signal.</p> <p>If the period of the signal is less than 5.00ns then BURST mode is not allowed.</p> <p>The burst trigger signals are as follows:</p> <ul style="list-style-type: none"><li>■ External Input (See "EXT INPUT.")</li><li>■ MAN key press (See "MAN.")</li><li>■ *TRG (See "*TRG" in Chapter 6.)</li></ul> <p>The mode is common to channels 1 and 2 in dual channel instruments, it cannot be set individually for each channel.</p> <p>The number of pulses or double-pulses per burst is set with the COUNT Function.</p>
<b>Remote Commands</b>	:INPut:TRIGger:MODE BURSt
<b>Related Keys</b>	AUTO, TRIG, GATE, E.WIDTH, MAN, EXT INPUT COUNT
<b>Interface Commands</b>	None.

---

**COMP**

**Description** The COMP key complements the signals at both the OUTPUT and OUTPUT.  
When COMP is disabled (which is the default condition) the OUTPUT signal is output as specified by the setting. When COMP is enabled (that is when the LED is lighted the OUTPUT signal is inverted with respect to the setting.  
In both cases, disabled or enabled, the OUTPUT is the inverted form of OUTPUT.

**Remote Commands** :OUTPut:PULSe:POLarity NORM|COMP

**Related Keys** OUTPUT, OUTPUT

**Interface Commands** None.

---

## COUNT

<b>Description</b>	<p>The COUNT Function sets the number of pulses or double-pulses contained in the burst when the instrument is in the burst operating mode. The number of pulses can be from 1 to 9999. The default count is 1.</p> <p><math>1 \leq \text{COUNT} \leq 9999</math> Resolution: 1 Default: 1</p> <p>The burst count is common to channels 1 and 2 in dual channel instruments, it cannot be set individually for each channel.</p>
<b>Remote Commands</b>	:PULSe:COUNt <value> MIN MAX
<b>Related Keys</b>	BURST
<b>Interface Commands</b>	None.

---

**DCYC**

**Description** This key is used to set the on-time of the pulse as a percentage of the period. It can be used as an alternative to the WIDTH key, which specifies the on-time in units of time. The duty cycle can be set to any integer, percentage value from 1% to 99%. The default for the duty cycle is that it is not active and the on-time of the pulse is set by the WIDTH key. When the duty cycle is active the default value is 10%.

$$1\% \leq \text{DUTY CYCLE} \leq 99\%$$

Resolution: 1

Default: mode = OFF

duty cycle = 10 percent

If DOUBLE PULSE is inactive then the on-time for the pulse is

$$\text{On-Time} = (\text{PERIOD})(\text{DCYC})/100$$

If DOUBLE PULSE is active then the on-time for the pulse is

$$\text{On-Time} = (\text{PERIOD})(\text{DCYC})/200$$

**PERIOD-DCYC Relationship:**

See Table 5-1

**DOUB-DCYC Relationship:**

- If On-Time < 1.00ns  
then On-Time  $\leq 0.8 \times \text{DOUB} - 1.10\text{ns}$
- If On-Time  $\geq 1.00\text{ns}$   
then On-Time  $\leq 0.8 \times \text{DOUB} - 0.6\text{ns}$

**DCYC-TRIG Relationship:**

DCYC and TRIG are incompatible. This is because the period is not known when the instrument is in trigger

## DCYC

operating mode. When duty cycle is enabled the on-time is calculated from the period of the pulse.

**Remote Commands** :PULSe:TIMing:DutyCYClE <value>|MIN|MAX  
:PULSe:TIMing:DutyCYClE:MODE ON|OFF|1|0

**Related Keys** WIDTH

**Interface Commands** None.

---

**DELAY**

<b>Description</b>	<p>The DELAY key is used to set the delay between the output of a trigger (at the TRIG OUTPUT) and the beginning of the pulse. The delay can be from 0.00ps up to 99.9ms. The default delay is 0.00ps, note, however, that there is a constant fixed delay of 18ns which should be added to the programmable delay offered by this key.</p> <p><math>0.00\text{ps} \leq \text{DELAY} \leq 99.9\text{ms}</math> Resolution: See Table 5-3. Default: 0.00ps Pulse Delay = DELAY + fixed delay (18ns)</p> <p>PERIOD-DELAY Relationship: See Table 5-1</p>
<b>Remote Commands</b>	<p>:PULSe:TIMing:DELAy &lt;value&gt; MIN MAX</p>
<b>Related Keys</b>	<p>None.</p>
<b>Interface Commands</b>	<p>None.</p>

---

## DISABLE

### Description

The DISABLE key is used to disable or enable an output. There are separate disable keys for OUTPUT and  $\overline{\text{OUTPUT}}$ .

In the disabled state, (the default state, which is indicated by the LED being lit) the OUTPUT or  $\overline{\text{OUTPUT}}$  is disabled.

In the enabled State (indicated by the LED being unlit) the OUTPUT or  $\overline{\text{OUTPUT}}$  is enabled.

The output amplifier is switched off during the time an output is disabled.

The OUTPUT and  $\overline{\text{OUTPUT}}$  are automatically disabled under the following circumstances:

- At power-on
- After a reset (\*RST)
- When the standard setting is recalled (\*RCL 0)
- When an overvoltage occurs. See below for additional information.

#### Overvoltage Condition:

The window in the following diagram defines the output voltage conditions under which an enabled output will remain enabled.

A voltage that exceeds a window limit causes an output to be automatically disabled.

### Note



---

If an output drives into an open circuit, the output voltage is doubled. The instrument disables the outputs if the amplitude exceeds 6.5V or if the level goes above 6.5V or below -6.5V

---



DISABLE

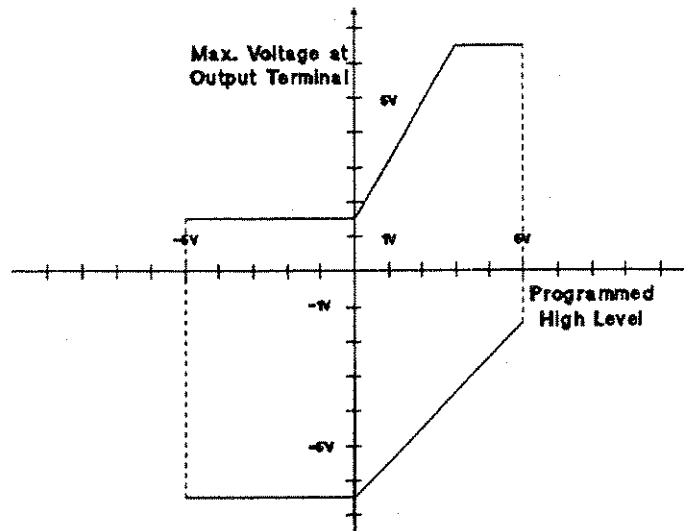

Figure 5-1. Output Voltage Window

**Remote Commands**

OUTPUT:  
:OUTPut:PULSe:STATe ON|OFF|1|0

OUTPUT:  
:OUTPut:PULSe:CStAtE ON|OFF|1|0

**Related Keys**

OUTPUT, OUTPUT

**Interface Commands**

None.

---

## DOUB

**Description** The DOUB operates in double pulse mode. This key sets the delay of the second pulse with respect to the first pulse. The second pulse can be delayed by between 2.50ns and 99.9ms. The standard setting does not have the double pulse enabled. The default value for the double pulse, when it is enabled, is 200 $\mu$ s

$2.50\text{ns} \leq \text{DOUBLE PULSE DELAY} \leq 99.9\text{ms}$

Specified Range: 3.33ns to 99.9ms

Resolution: See Table 5-3 earlier in the text

. Default: mode = OFF

double pulse delay = 200 $\mu$ s

It is not possible to set the delay of the first pulse with respect to the trigger. However, there is a fixed delay of 18ns between the trigger and the first pulse.

**Width:**

If duty cycle is inactive then the on-time of the pulse is given by the programmed value of WIDTH.

If duty cycle is active then the on-time of the pulse is given by

On-Time = PERIOD $\times$ DCYC/200

**PERIOD-DOUB Relationship:**

See Table 5-2

**WIDTH-DOUB Relationship:**

$0.8 \times \text{DOUB} - 0.6\text{ns}$

**DOUB-DCYC Relationship:**

$0.8 \times \text{DOUB} - 0.6\text{ns}$

**DOUB**

**Remote Commands** :PULSe:TIMing:DOUBle <value>|MIN|MAX  
:PULSe:TIMing:DOUBle:MODE ON|OFF|1|0 (OFF = DEL /  
ON = DOUB)

**Related Keys** None.

**Interface Commands** None.

---

## ERROR

**Description** The ERROR message is located to the left of the display on the front of the instrument. It lights when an error condition occurs, either during the power-on self-test or during the operation of the instrument. There are three types of error.

■ **F-Type Power-On Errors:**

These are indicated by an error number, preceded by the letter F on the display of the instrument. F-type errors indicate that the instrument cannot operate under the conditions represented by the error code.

See Table H-1 for a Description of the error codes.

■ **E-Type Power-On Errors:**

These are indicated by an error number, preceded by the letter E on the display of the instrument. E-type errors indicate that the capability of the instrument is restricted, but the instrument can still operate.

See Table H-1, for a Description of the error codes and how the capability of the instrument is restricted.

■ **Device Errors:**

These are errors caused during normal operation when an attempt has been made to exceed the physical limits of the instrument. Blinking LEDs indicate when and which error is present in the instrument.

See Table 5-1 or one of the Function listings in this chapter for a description of the parametric relationships.

## ERROR

**Remote Commands** :SYSTem:ERROr?, :SYSTem:DERRor?, \*TST?

**Related Keys** None.

**Interface Commands** None.

---

## E. WIDTH

**Description** The E. WIDTH LED lights when the external width operating mode is active.

**External Width Operating Mode:**

In the external width operating mode the pulse width and period are controlled by a signal applied at the EXT INPUT. When the input signal is above the threshold level the output signal is at the high level, when the input signal is below the threshold level the output signal is at the low level. The threshold level is set by the THRE key. The high and low levels of the output signal are set with the HIGH and LOW keys or with the AMPL and OFFS keys.

Select the E. WIDTH mode by pressing the mode select key repeatedly until the E.WIDTH LED lights.

The mode is common to channels 1 and 2 in the dual channel instrument, it cannot be set individually for each channel.

The external input signal must satisfy the following criteria:

Input bandwidth:

DC to 500MHz

Input transitions:

< 50ns

Minimum amplitude:

≥ 300mVpp

**E. WIDTH**

**Remote Commands** : INPut:TRIGger:MODE ExternalWIDth

**Related Keys** AUTO, TRIG, BURST, GATE, EXT INPUT

**Interface Commands** None.

---

## EXCESSIVE

**Description** The EXCESSIVE LED is used to indicate that the timing parameters have been set in such a way that the signal can not reach it's full amplitude

It is possible to set leading and trailing edges, together with other timing parameters, in such a way that the full amplitude of the output signal can not be reached.

**Remote Commands** :SYSTem:DERRor?

**Related Keys** LEAD, TRA, WIDTH, DCYC, PERIOD

**Interface Commands** None.



---

**EXT INPUT****Caution**

The maximum external voltages which can be applied to this input are  $\pm 10V$ .

---

**Description**

EXT INPUT is the input for the signal used in the trigger, gate, burst, and external width operating modes.

The external input is disabled when the automatic operating mode is active.

Slope:

■ POS (positive), default:

The trigger, gate, and burst operating modes are triggered on the positive slope of the external input signal.

The gate closes on the negative slope of the external input signal in the gate operating mode.

In the external width operating mode the output signal switches to the on-state on the positive slope of the input signal and reverts to the off-state on the negative slope of the external input signal.

■ NEG (negative)

The trigger, gate, and burst operating modes are triggered on the negative slope of the external input signal.

The gate closes on the positive slope of the external input signal in the gate operating mode.

In the external width operating mode the output signal switches to the on-state on the negative slope of the input signal and reverts to the off-state on the positive slope of the external input signal.

## EXT INPUT

### Threshold:

This is the level at which the input signal activates a response in the trigger, gate, burst, and external width operating modes.

$$-5.0V \leq \text{THRE} \leq 5.0V$$

Resolution: 0.1V

Default: 0.0V

**Remote Commands** None.

**Related Keys** AUTO, TRIG, GATE, BURST, E.WIDTH  
Slope, THRE

**Interface Commands** None.

---

**GATE**

**Description** The gate operating mode is selected when the GATE LED is lit

**Gate Operating Mode**  
A continuous waveform is generated for the duration of the gate signal.

The gate signal can be of two types:

- External Input (See "EXT INPUT.")
- Manual key (See "MAN")

The first pulse generated is synchronous with the leading edge of the gate signal.

The last pulse gated is always completed.

The gate operating mode is selected by pressing the mode select key repeatedly until the GATE LED lights.

The mode is common to Channels 1 and 2 in dual channel instruments, it cannot be selected individually for each channel.

**Remote Commands** :INPut:TRIGger:MODE GATE

**Related Keys** AUTO, TRIG, BURST, E. WIDTH  
MAN, 1 PULSE

**Interface Commands** None.

---

## HIGH

**Description** The HIGH key is used to set the high level of the output signal. The high level can be at any level between -4.90V and 5.00V. The LOW key should be used to set the low level of the output signal.

$-5.10V \leq \text{HIGH} \leq 5.20V$   
Specified Range: -4.90 to 5.20V  
Resolution: 0.01V  
Default: 0.50V

High level, low level, amplitude, and offset are coupled. To alternate between the HIGH and LOW, and AMPL and OFFS settings you should press the HIGH or LOW buttons repeatedly until the pair of LEDs for the functions you require are lighting.

The high level is equivalent to the sum of the offset and half the amplitude.

High Level  $\equiv$  Offset + (Amplitude/2)  
Overvoltage disabling: See "DISABLE."

**Remote Commands** :PULSe:LEVel:HIGH <value>|MIN|MAX

**Related Keys** AMPL, LOW, OFFS

**Interface Commands** None.

---

**LCL**

<b>Description</b>	<p>If the instrument is in the remote control programming mode, the instrument is returned to local control operation. However, operation cannot be returned to local control if local lockout is active.</p> <p>Local lockout is cleared by the interface command <b>GTL</b> or at power-on.</p> <p>If the instrument is in the local control programming mode pressing this key causes the instrument's interface address to be displayed, this is displayed in the format <b>A nn</b> where <b>nn</b> is the address, for example, <b>A 11</b> would indicate address 11.</p> <p>Addresses can be in the range 0 to 30.</p> <p>To change the interface address when in local control mode, perform the following sequence:</p> <ol style="list-style-type: none"><li>1. Depress the <b>LCL</b> key.</li><li>2. Change the address with the vernier keys.</li></ol> <p>The address cannot be changed under the following circumstances:</p> <ul style="list-style-type: none"><li>■ If the instrument is talk or listen addressed</li><li>■ If a service request is pending.</li><li>■ If the instrument is in the remote control state</li></ul>
<b>Remote Commands</b>	None.
<b>Related Keys</b>	None.
<b>Interface Commands</b>	<b>GTL, LLO, SPD, SPE</b>

---

## LEAD

**Description** This key is used to set the time taken for the leading edge of the pulse to reach 90% of the amplitude level from the 10% of the amplitude level.

The leading edge transition time can be varied from 670ps to 100 $\mu$ s.

$670\text{ps} \leq \text{LEAD} \leq 100\mu\text{s}$

Specified Range: 1ns to 100 $\mu$ s

Resolution: See Table 5-3

Default: 1.00 $\mu$ s

**LEAD-TRA Relationship:**

The leading and trailing edge transition times are independently programmable, however they must remain within the following, overlapping ranges:

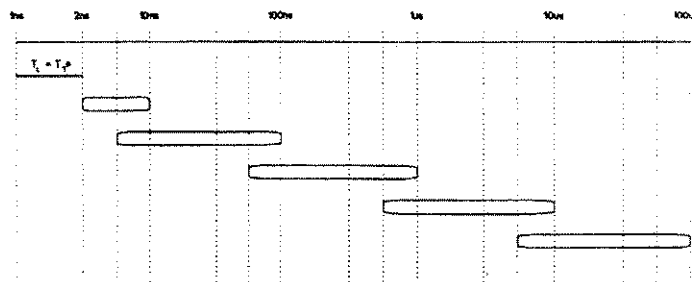

**Figure 5-2.**

### **Leading Edge/Trailing Edge Transition Time Relationships**

\* Leading and trailing edges are assigned the same value.

It is possible to set leading and trailing edges, together with other timing parameters, in such a way that the full amplitude of the output signal can not be reached. When this happens it is indicated by the EXCESSIVE LED lighting.

**LEAD**

**Remote Commands** :OUTPut:PULSe:EDGE:LEADing

**Related Keys** TRA, EXCESSIVE

**Interface Commands** None.

---

## LIMIT

**Description** High and low level limits are set for OUTPUT and OUTPUT. The levels of the output signal will not exceed these limits.

Enabling the limit function (The LIMIT key LED is lighted.) makes the current levels the limit levels.

To change the limits:

- Disable the LIMIT Function if it is enabled.
- Set the levels required for the limit values.
- Enable the LIMIT Function.

If the LIMIT Function is active, incrementing or decrementing stops when the limit is reached.

**Remote Commands** :PULSe:LEVel:LIMit ON|OFF|1|0

**Related Keys** HIGH, LOW, AMPL, OFFS

**Interface Commands** None.



---

**LOW**

**Description** The LOW key is used to set the low level of the output signal. The low level can be at any level between -5.00V and 4.90V. The HIGH key should be used to set the upper level of the output signal

$$-5.20V \leq \text{LOW} \leq 5.10V$$

Specified Range: -5.00V to 4.90V

Resolution: 0.01V

Default: -0.50V

Low level, high level, amplitude and offset are coupled. To alternate between the HIGH and LOW, and AMPL and OFFS settings you should press the HIGH or LOW buttons repeatedly until the pair of LEDs for the functions you require are lighting.

The low level is equivalent to the offset less half of the amplitude.

$$\text{Low Level} \equiv \text{Offset} - \text{Amplitude}/2$$

Overvoltage disabling: See "DISABLE"

**Remote Commands** :PULSe:LEVel:LOW <value>

**Related Keys** AMPL, HIGH, OFFS

**Interface Commands** None.

---

## MAN

<b>Description</b>	<p>The manual Function simulates an external input signal in the trigger, gate, and burst operating modes.</p> <p>The external input (EXT INPUT) is disabled during manual (MAN) operations.</p> <p><b>Trigger Operating Mode:</b> One pulse or double-pulse is generated per key press.</p> <p><b>Gate Operating Mode:</b> A continuous pulse stream is generated during the time the MAN key is depressed.</p> <p><b>Burst Operating Mode:</b> One pulse or double-pulse burst is generated per key press.</p>
<b>Remote Commands</b>	None.
<b>Related Keys</b>	1 PULSE, EXT INPUT
<b>Interface Commands</b>	None.

---

**MEM**

**Description** The MEM key is used to access the the internal memory as part of a save or recall operation.

**SAVE:**

The instrument's current setting is stored in internal memory.

**SAVE execution:**

- Press MEM (memory).
- Enter the location ( 1-19 ).
- Press SAV (save).

**RCL (recall):**

A setting is copied from internal memory and made the instrument's current setting.

**RCL execution:**

- Press MEM (memory).
- Enter the location ( 0-20 ).
- Press RCL (recall).

Location 0 contains the standard setting. See \*RST, Chapter 6 for a description of the standard setting.

Locations 1-19 are user stored settings.

**Remote Commands** \*SAV <location>  
\*RCL <location>

**Related Keys** RCL, SAV

**Interface Commands** None.

---

## OFFS

**Description** The OFFS key is used to set the offset of the output signal. It is used together with the AMPL key to set the upper and lower levels of the output signals. The offset can be set between -4.95V and 4.95V.

$$-5.15V \leq \text{OFFS} \leq 5.15V$$

Specified Range: -4.95V to 4.95V

Resolution: 0.01V

Default: 0.00V

Offset, amplitude, high level, and low level are coupled. To alternate between the HIGH and LOW, and AMPL and OFFS settings you should press the HIGH or LOW buttons repeatedly until the pair of LEDs for the functions you require are lighting.

The offset is equivalent to half the distance between the high and low levels.

$$\text{Offset} \equiv (\text{High Level} + \text{Low Level}) / 2$$

Overvoltage disabling: See "DISABLE."

**Remote Commands** :PULSe:LEVel:OFFSet <value>|MIN|MAX

**Related Keys** AMPL, HIGH, LOW

**Interface Commands** None.

---

**OUTPUT**
**Caution**

---

The maximum external voltages which can be applied to the outputs are  $\pm 5V$

---

**Description****OUTPUT:**

The OUTPUT connector is where the output signal as defined by the setting is available.

OUTPUT has it's own separate DISABLE Function.

The COMP and LIMIT Functions apply to OUTPUT.

 **$\overline{\text{OUTPUT}}$ :**

$\overline{\text{OUTPUT}}$  is the inverted format of the OUTPUT signal defined by the setting.

$\overline{\text{OUTPUT}}$  has it's own separate DISABLE function.

The COMP and LIMIT Functions apply to  $\overline{\text{OUTPUT}}$ .

**Remote Commands****OUTPUT:**

```
:OUTPut:PULSe:STATe ON|OFF|1|0
```

 **$\overline{\text{OUTPUT}}$ :**

```
:OUTPut:PULSe:CSTate ON|OFF|1|0
```

**Related Keys**

COMP, LIMIT, DISABLE

**Interface Commands**

None.

---

## RANGE

<b>Description</b>	The range Function increments or decrements the displayed value. The up arrow increments the displayed value by a factor of ten, the down arrow decrements the displayed value by a factor of ten
<b>Remote Commands</b>	None.
<b>Related Keys</b>	VERNIER
<b>Interface Commands</b>	None.

---

**RCL**

**Description** A setting is copied from internal memory and made the current setting for the instrument.

Execution:

1. Press MEM (memory).
2. Specify the location ( 0-20 ).
3. Press RCL (recall).

Location 0 contains the standard setting. See \*RST, Chapter 6 for a description of the standard setting.

Locations 1-19 are user stored settings.

**Remote Commands** \*RCL <location>

**Related Keys** MEM, SAV

**Interface Commands** None.

---

## RMT

<b>Description</b>	The RMT LED indicates when the instrument is enabled for remote control operation.  The front panel controls are inactive except for LCL. LCL can not be used if local lockout is active.
<b>Remote Commands</b>	None.
<b>Related Keys</b>	ADS, SRQ, LCL
<b>Interface Commands</b>	GTL, LLO, REN



---

**SAVE**

<b>Description</b>	<p>The instrument's setting is stored in internal memory.</p> <p>SAVE execution:</p> <ul style="list-style-type: none"><li>■ Press MEM (memory).</li><li>■ Enter the location ( 1-19).</li><li>■ Press SAV (save).</li></ul> <p>Saving to location 0 (standard setting) is not allowed.</p> <p>The scope of the saved setting is identical to the scope of the standard setting; see Chapter 6, *RST.</p> <p>SAVE is identical to *SAV; see Chapter 6.</p>
<b>Remote Commands</b>	*SAV <location>
<b>Related Keys</b>	MEM, RCL
<b>Interface Commands</b>	None.

---

## SET

**Description** The instrument setting is set as follows:

PERIOD: no change<sup>†</sup>  
WIDTH: PERIOD / 2  
DELAY: 0.00ps  
DOUB: Mode = OFF  
Delay = no change<sup>†</sup>  
Transitions: 10% of PERIOD, min. 1ns  
DCYC: Mode = no change<sup>†</sup>  
Duty cycle = 50 percent  
Operating Mode: Automatic  
Levels: no change<sup>†</sup>  
Output Format: no change<sup>†</sup>

<sup>†</sup> The values are the programmed values prior to the SET operation. If PERIOD was under-programmed it will be set to 3.33ns.

**Note**



---

Set is not related to the device command :SYSTem:SET.

---

**Remote Commands** None.

**Related Keys** None.

**Interface Commands** None.

---

**Slope**

**Description** These two keys (one an upward ramping slope and the other a downward ramping slope) set the slope of the external input signal on which the trigger is activated.

POS (positive), default:  
 The trigger, gate, and burst operating modes are triggered on a positive slope.

The gate closes on the negative slope of the trigger signal in the gate operating mode.

In the external width operating mode the output signal switches to the on-state on the positive slope of the input signal and reverts to the off-state on the negative slope of the external input signal.

NEG (negative):  
 The trigger, gate, external width and burst operating modes are triggered on a negative slope.

The gate closes on the positive slope of the trigger signal in the gate operating mode.

In the external width operating mode the output signal switches to the on-state on the negative slope of the input signal and reverts to the off-state on the positive slope of the external input signal.

Selecting both slopes is not allowed.

**Remote Commands** :INPut:TRIGger:SLOPe POS|NEG

**Related Keys** THRE, EXT INPUT

**Interface Commands** None.

---

## SRQ

**Description** The SRQ LED indicates when a service request is pending, that is that the interface line SRQ is in the asserted state.

The interface address cannot be changed when a service request is pending.

**Remote Commands** None.

**Related Keys** RMT, ADS, LCL

**Interface Commands** SPE, SPD

---

**THRE**

**Description** The THRE key sets the level at which the signal on the EXT INPUT causes a trigger. The threshold level can be set at between -5.0V and 5.0V.

$-5.0V \leq \text{THRESHOLD} \leq 5.0V$

Resolution: 0.1V

Default: 0.0V

Input impedance: 50Ω

**Remote Commands** :INPut:TRIGger:THReshold <value>|MIN|MAX

**Related Keys** Slope, EXT INPUT

**Interface Commands** None.

---

## TRA

**Description** This key is used to set the time taken for the trailing edge of the pulse to reach 10% of the amplitude level from the 90% of the amplitude level.

The trailing edge transition time can be varied from 670ps to 100 $\mu$ s.

$670\text{ps} \leq \text{TRA} \leq 100\mu\text{s}$   
Specified Range: 1ns to 100 $\mu$ s  
Resolution: See Table 5-3  
Default: 1.00 $\mu$ s

**LEAD-TRA Relationship:**  
The leading and trailing edge transition times are independently programmable, however they must remain within overlapping ranges as shown in Figure 5-2.

It is possible to set leading and trailing edges, together with other timing parameters, in such a way that the full amplitude of the output signal can not be reached. When this happens it is indicated by the EXCESSIVE LED lighting.

**Remote Commands** :OUTPut:PULSe:EDGE:TRAILing

**Related Keys** LEAD, EXCESSIVE

**Interface Commands** None.

---

**TRIG**

<b>Description</b>	<p>The TRIG LED indicates that the instrument is operating in trigger operating mode.</p> <p>Trigger operating mode: One pulse or double-pulse is generated for each trigger signal.</p> <p>To select trigger operating mode press the mode key repeatedly until the TRIG LED is lit.</p> <p>The mode is common to channels 1 and 2 in dual channel instruments, it cannot be set individually for each channel.</p> <p>Trigger Signals:</p> <ul style="list-style-type: none"> <li>■ External Input (See "EXT INPUT")</li> <li>■ Manual key press (See "MAN")</li> <li>■ *TRG (See Chapter 6)</li> <li>■ Single pulse (See "1 PULSE")</li> </ul> <p>The period is controlled by the external input signal.</p> <p>Conflict: The DCYC Function and the trigger operating mode are incompatible.</p>
<b>Remote Commands</b>	<pre>:INPut:TRIGger:MODE TRIG *TRG</pre>
<b>Related Keys</b>	AUTO, GATE, BURST, E.WIDTH
<b>Interface Commands</b>	None.

---

## TRIG OUTPUT



### Caution



The maximum external voltages which can be applied to this output are +7V, -2V

---

### Description

TRIGGER OUTPUT is the reference signal for the differential output signals.

The trigger output signal is a TTL level signal. (high at 2.40V, low at 0.3V into 50Ω)

PERIOD-TRIG OUTPUT On-Time Relationship:

- If  $3.33\text{ns} \leq \text{PERIOD} < 100\text{ns}$   
then TRIG OUTPUT On-Time =  $0.5 \times \text{PERIOD}$
- If  $100\text{ns} \leq \text{PERIOD} < 1.00\mu\text{s}$   
then TRIG OUTPUT On-Time =  $0.95 \times \text{PERIOD}$
- If  $1.00\mu\text{s} \leq \text{PERIOD} < 10.0\mu\text{s}$   
then TRIG OUTPUT On-Time =  $0.995 \times \text{PERIOD}$
- If  $10.0\mu\text{s} \leq \text{PERIOD} \leq 99.9\text{ms}$   
then TRIG OUTPUT On-Time =  $0.9995 \times \text{PERIOD}$

The differential outputs are delayed approximately 18ns (fixed delay) with respect to the trigger output signal.

The trigger output signal is delayed approximately 16ns (fixed delay) with respect to the external input signal.

**Remote Commands** None.

**Related Keys** None.

**Interface Commands** None.



---

**Units**

**Description** The units are located to the right of the display. An LED indicates which units are currently active. The units are abbreviated, the meanings of these abbreviations are given in the table below

**Table 5-4. Units**

ps: pico seconds, E-12

ns: nano seconds, E-9

$\mu$ s: micro seconds, E-6

ms: milli seconds, E-3

V: Volts

%: percent

**Remote Commands** None.

**Related Keys** None.

**Interface Commands** None.

---

## VERNIER

**Description** The vernier keys are used to set parameter values or change the interface address.

Each key corresponds to a display segment. The left-most keys correspond to the left-most segment, the up arrow increments the contents of the left-most segment, the down arrow decrements the contents of the left-most segment. The middle keys correspond to the middle segment in the same way, and the right-most keys correspond to the right-most segment.

Incrementing or decrementing a parameter stops when the limit of the parameter is reached.

If the LIMIT Function is active, incrementing or decrementing a level Function stops when the limit is reached.

See LCL for changing the interface address.

**Remote Commands** None.

**Related Keys** RANGE

**Interface Commands** None.

---

**WIDTH**

**Description** The WIDTH key is used to set the on-time of the pulse.  
 The width can be between 1.50ns and 99.9ms.  
 $1.00\text{ns} \leq \text{WIDTH} \leq 99.9\text{ms}$   
 Specified Range: 1.50ns to 99.9ms  
 Resolution: See Table 5-1 earlier in the text.  
 Default: 100 $\mu\text{s}$

**Note**  The differential outputs are delayed approximately 18ns (fixed delay) with respect to the trigger output signal.

- PERIOD-WIDTH Relationship:  
See Table 5-1
- WIDTH-DOUB Relationship:  
0.8xDOUB-0.60ns

**Remote Commands** :PULSe:TIMing:WIDth <value>|MIN|MAX

**Related Keys** DCYC, PERIOD

**Interface Commands** None.



## Remote Commands, Part I: Common Commands

---

Table 6-1. Common Command Summary

Command	Function
*CLS	Clear Status
*ESE	Standard Event Status Enable
*ESE?	Standard Event Status Enable Query
*ESR?	Standard Event Status Register Query
*IDN?	Identification Query
*LRN?	Learn Device Setup Query
*OPC	Operation Complete
*OPC?	Operation Complete Query
*RCL	Recall
*RST	Reset
*SAV	Save
*SRE	Service Request Enable
*SRE?	Service Request Enable Query
*STB?	Read Status Byte Query
*TRG	Trigger
*TST?	Self Test Query
*WAI	Wait to Continue

---

**\*CLS**

Clear status command.

**Syntax** \*CLS**Definition** The \*CLS command clears the following:

- Error queue
- Standard event status register (ESR)
- Status byte register bit 5 (STB)
- A service request
- OCAS and OQAS

No changes are made to the following:

- Status byte register bits 6, 4, 2-0 (STB)
- Output queue
- Event status enable register (ESE)
- Service request enable register (SRE)
- Key Queue

After the \*CLS command the instrument is left in the idle state. The instrument setting is unaltered by the command, though \*OPC/\*OPC? actions are canceled.

If the \*CLS command occurs directly after a program message terminator, the output queue and MAV, bit 4, in the status byte register are cleared, and if condition bits 2-0 of the status byte register are zero, MSS, bit 6 of the status byte register is also zero.

**Related Command** SDC**Example** OUTPUT 711; "\*CLS"

---

**\*ESE**

Standard event status enable command.

**Syntax** \*ESE <wsp> <value>  
0 ≤ value ≤ 255

**Definition** The \*ESE command sets bits in the standard event status enable register (ESE) which enable the corresponding bits in the standard event status register (ESR).

The register is cleared:

- At power-on
- By sending a value of zero

The register is not changed by the \*RST and \*CLS commands.

<u>BIT</u>	<u>MNEMONIC</u>	<u>BIT VALUE</u>
7	PON	128
6	Not used	0
5	CME	32
4	EXE	16
3	DDE	8
2	QYE	4
1	Not used	0
0	OPC	1

**The Event Status Enable Register**

\*ESE

**Related Commands**    \*ESE?

**Example**    OUTPUT 711; "\*ESE 21"





---

**\*ESE?**

Standard event status enable query.

**Syntax** \*ESE?

**Definition** The standard event status enable query returns the contents of the standard event status enable register.  
 $0 \leq \text{contents} \leq 255$

BIT	MNEMONIC	BIT VALUE
7	PON	128
6	Not used	0
5	CME	32
4	EXE	16
3	DDE	8
2	QYE	4
1	Not used	0
0	OPC	1

**The Event Status Enable Register**

**Related Commands** \*ESE

**Example** OUTPUT 711; "\*ESE?"  
ENTER 711; A\$

---

**\*ESR?**

Standard event status register query.

**Syntax** \*ESR?**Definition** The standard event status register query returns the contents of the standard event status register. The register is cleared after being read. $0 \leq \text{contents} \leq 255$ 

<u>BITS</u>	<u>MNEMONICS</u>	<u>BIT VALUE</u>
7	PON	128
6	Not used	0
5	CME	32
4	EXE	16
3	DDE	8
2	QYE	4
1	Not used	0
0	OPC	1

**The Standard Event Status Register****Related Commands** None.**Example**  
OUTPUT 711; "\*ESR?"  
ENTER 711; A\$

---

**\*IDN?**

Identification query.

**Syntax** \*IDN?

**Definition** The identification query commands the instrument to identify itself over the interface.

Response: HEWLETT-PACKARD, 8130A, 0, n.n

HEWLETT-PACKARD: manufacturer

8130A: instrument model number

0: indicates serial numbers  
are not provided.

n.n: firmware revision level

**Related Commands** None.

**Example** DIM A\$ [100]  
OUTPUT 711; "\*IDN?"  
ENTER 711; A\$

---

**\*LRN?**

Learn device setting query.

**Syntax** \*LRN?**Definition** The learn query returns the status of the instrument's setting.

The response message can be transmitted again as a program message without requiring any alterations.

The returned commands are listed in the table below.

The learn response message is a single ASCII string without image specifiers. The format of the table is for legibility only.

**Table 6-2. PULSE \*LRN?**

```
:INPut:TRIGger :STATe ON|OFF;  
      :MODE AUTO|TRIGGER|GATE|BURST|EWIDTH|TRANSDUCER;  
      :SLOPe POS|NEG;  
      :THReshold <value>;  
  
:PULSe:COUNT <value>;  
  
:PULSe:TIMing :PERiod <value>;
```

Table 6-2. PULSE \*LRN? (continued)

```
:PULSe1:TIMing :WIDTh <value>;  
                :DELay <value>;  
                :DOUBle <value>;  
                :DOUBle:MODE ON|OFF;  
                :DutyCYCle <value>;  
                :DutyCYCle:MODE ON|OFF;  
  
:PULSe1:LEVel  :HIGH <value>;  
                :LOW <value>;  
                :LIMit ON|OFF;  
  
:OUTPut1:PULSe :POLarity NORM|COMP  
                :STATe ON|OFF;  
                :CSTATe ON|OFF;  
  
:PULSe2:TIMing :WIDTh <value>;  
                :DELay <value>;  
                :DOUBle <value>;  
                :DOUBle:MODE ON|OFF;  
                :DutyCYCle <value>;  
                :DutyCYCle:MODE ON|OFF;
```

\*LRN?

**Table 6-2. PULSE \*LRN? (continued)**

```
:PULSe2:LEVel :HIGH <value>;  
                :LOW <value>;  
                :LIMit ON|OFF;  
  
:OUTPut2:PULSe :POLarity NORM|COMP;  
                :STATe ON|OFF;  
                :CSTate ON|OFF;
```

**Note**



---

Channel 2 command paths apply only to dual channel instruments.

---

**Note**



---

For definitions of <value>, see Chapter 7

---

**Related Commands**

None.

**Example**

```
DIM A$ [1000]  
OUTPUT 711; "*LRN?"  
ENTER 711; A$
```

---

**\*OPC**

Operation complete command.

**Syntax** \*OPC

**Definition** The instrument parses all program message units in the input queue and, after a wait period of two seconds, sets the operation complete bit in the standard event status register (ESR).

The following actions cancel \*OPC (device goes to Operation Complete, Command Idle State):

- Power-on
- the *dcas* line on the interface is asserted.
- \*CLS
- \*RST

**Related Commands** \*OPC?, \*WAI

**Example** OUTPUT 711;"\*CLS;\*ESE 1;\*SRE 32"  
OUTPUT 711;"\*OPC"

---

**\*OPC?**

Operation complete query.

**Syntax** \*OPC?

**Definition** The instrument parses all program message units in the input queue and, after a wait period of two seconds, places an ASCII '1' in the output queue.

The following actions cancel \*OPC? (device goes to Operation Complete, Command Idle State):

- Power-on
- the *dcas* line on the interface is asserted
- \*CLS
- \*RST

**Related Commands** \*OPC, \*WAI

**Example** OUTPUT 711; "\*OPC?"  
ENTER 711; A\$



---

**\*RCL**

Recall command

**Syntax** \*RCL <wsp> <location>  
 $0 \leq \text{location} \leq 19$

**Definition** An instrument setting from the internal RAM is made the current instrument setting.  
The instrument can recall twenty settings, locations 0-19.  
Location 0 = standard setting, see “\*RST.”  
Location 1-19 = user stored settings, see “\*SAV.”  
The \*RCL command is identical to the local function RCL (recall); see Chapter 5.

**Related Commands** \*SAV

**Example** OUTPUT 711;"\*RCL 3"

---

**\*RST**

Reset command.

**Syntax** \*RST

**Definition** The reset setting (standard setting) stored in ROM is made the instrument setting.

Pending \*OPC/\*OPC? actions are canceled.

Instrument state: the instrument is placed in the idle state awaiting a command.

The \*RST command clears the key queue.

The following are not changed:

- HP-IB (interface) state
- Instrument interface address
- Output queue
- Service request enable register (SRE)
- Standard event status enable register (ESE)

The commands and parameters of the reset state are listed in the following table.

\*RST

Table 6-3. Reset State (Standard Setting)

Commands	Parameters (Default)	Channel (Channel 2: in dual channel instruments)
:INPut		
:TRIGger		
:STATe	OFF	
:MODE	AUTO	
:SLOPe	POS	
:THREshold	0.0V	
:PULSe		
:COUNT	1	
:TIMing		
:PERiod	1.00ms	
:WIDTh	100 $\mu$ s	1/2
:DELay	0.00ps	1/2
:DOUBle	200 $\mu$ s	1/2
:MODE	OFF	1/2
:DutyCYCle	50 %	1/2
:MODE	OFF	1/2
:LEVel		
:HIGH	+0.50V	1/2
:LOW	-0.50V	1/2
:AMPLitude	1.00V	1/2
:OFFSet	0.00V	1/2
:LIMit	OFF	1/2
:OUTPut		
:PULSe		
:POLarity	NORM	1/2
:STATe	OFF	1/2
:CSTATe	OFF	1/2

**Related Commands** None.

**Example** OUTPUT 711; "\*RST"

---

**\*SAV**

Save command.

**Syntax** \*SAV <wsp> <location>  
 $1 \leq \text{location} \leq 19$

**Definition** The instrument setting is stored in RAM.  
The instrument can store nineteen settings, locations 1-19.  
The scope of the saved setting is identical to the scope of the standard setting.  
The \*SAV command is identical to the local function SAVE; see Chapter 5.

**Related Commands** \*RCL

**Example** OUTPUT 711; "\*SAV 3"

---

**\*SRE**

Service request enable register.

**Syntax** \*SRE <wsp> <value>  
 $0 \leq \text{value} \leq 255$

**Definition** The service request enable command sets bits in the service request enable register which enable the corresponding status byte register bits.

The register is cleared:

- At power-on
- By sending a value of zero.

The register is not changed by the \*RST and \*CLS commands.

<u>BITS</u>	<u>MNEMONICS</u>	<u>BIT VALUE</u>
7	Not used	0
6	RQS/MSS	64
5	ESB	32
4	MAV	16
3	Not used	0
2	Not used	0
1	Not used	0
0	H	1

**The Service Request Enable Register**

**\*SRE**

**Related Commands**    \*SRE?, \*STB?

**Example**            OUTPUT 711;"\*SRE 48"



---

**\*SRE?**

Service request enable query.

**Syntax** \*SRE?

**Definition** The service request enable query returns the contents of the service request enable register.

$0 \leq \text{contents} \leq 255$

<u>BITS</u>	<u>MNEMONICS</u>	<u>BIT VALUE</u>
7	Not used	0
6	RQS/MSS	64
5	ESB	32
4	MAV	16
3	Not used	0
2	Not used	0
1	Not used	0
0	H	1

**The Service Request Enable Register**

**Related Commands** \*SRE, \*STB?

**Example** OUTPUT 711; "\*SRE?"  
ENTER 711; A\$

---

**\*STB?**

Read status byte query.

**Syntax** \*STB?**Definition** The read status byte query returns the contents of the status byte register. $0 \leq \text{contents} \leq 255$ 

The MSS message is reported in bit six of the status byte register.

<u>BITS</u>	<u>MNEMONICS</u>	<u>BIT VALUE</u>
7	Not used	0
6	MSS	64
5	ESB	32
4	MAV	16
3	Not used	0
2	Not used	0
1	Not used	0
0	H	1

**The Status Byte Register****Related Commands** \*SRE, \*SRE?**Example** OUTPUT 711; "\*STB?"  
ENTER 711; A\$



**Table 7-3. :PULSe Command List**

Command	Parameter
:PULSe	
:COUNt	<value> MIN MAX
:COUNt?	
:EDGE	
:LEADing	<value> MIN MAX
:LEADing?	
:TRAILing	<value> MIN MAX
:TRAILing?	
:LEVel	
:AMPLitude	<value> MIN MAX
:AMPLitude?	
:HIGH	<value> MIN MAX
:HIGH?	
:LIMit	ON OFF 1 0
:HIGH? LOW?	
:AMPLitude? OFFSet?	
:LIMit?	
:LOW	<value> MIN MAX
:LOW?	
:OFFSet	<value> MIN MAX
:OFFSet?	

**Table 7-3. :PULSe Command List (continued)**

Command	Parameter
:TIMing	
:DELay	<value>   MIN   MAX
:DELay?	
:DOUBle	<value>   MIN   MAX
:MODE	ON   OFF   1   0
:MODE?	
:DOUBle?	
:DutyCYCle	<value>   MIN   MAX
:MODE	ON   OFF   1   0
:MODE?	
:DutyCYCle?	
:PERiod	<value>   MIN   MAX
:PERiod?	
:WIDTh	<value>   MIN   MAX
:WIDTh?	

**Table 7-4. :SYSTEM Command List**

<b>Command</b>	<b>Parameter</b>
<b>:SYSTEM</b>	
<b>:DERRor?</b>	<b>[NUMeric STRing]</b>
<b>:ERRor?</b>	<b>[NUMeric STRing]</b>
<b>:KEY</b>	<b>&lt;code&gt;</b>
<b>:KEY?</b>	
<b>:SET</b>	<b>&lt;data&gt;</b>
<b>:SET?</b>	

## :INPut:TRIGger

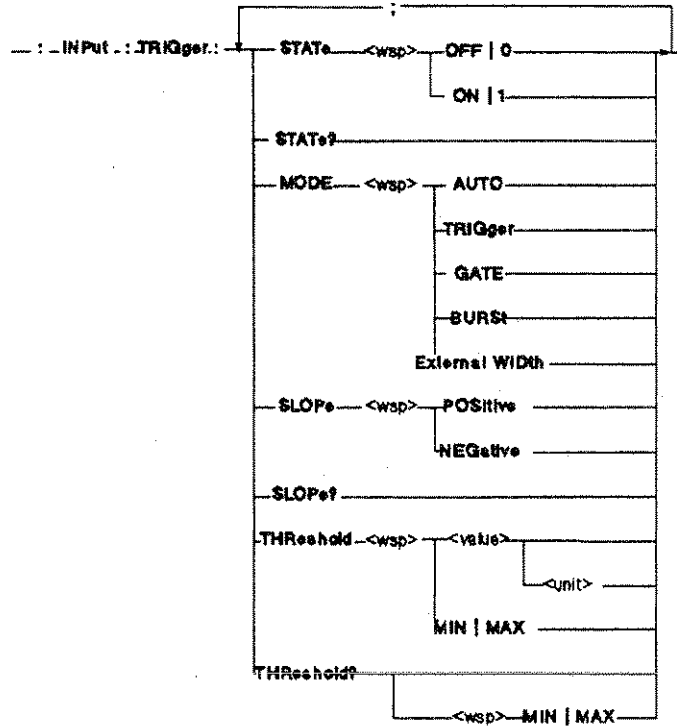

Figure 7-1. :INPut:TRIGger Syntax Diagram

---

## :INPut:TRIGger:MODE

**Description**    :INPut:TRIGger:MODE AUTO (Default)  
This command places the instrument into automatic operating mode. A continuous waveform (free run mode) is generated. The external input is disabled.

:INPut:TRIGger:MODE TRIGger  
This command places the instrument into trigger operating mode. One pulse or double pulse signal is generated per trigger signal: EXT INPUT or \*TRG command.

**Note**



---

Conflict  
<Trigger-DCYC>  
:INPut:TRIGger:MODE TRIGger and  
:PULSe:TIMing:DutyCYCLE:MODE ON are  
incompatible.

---

:INPut:TRIGger:MODE GATE  
This command places the instrument into gate operating mode. Pulses or double pulses are generated for the duration of the gate.

:INPut:TRIGger:MODE BURSt  
This command places the instrument into burst operating mode. A specified number of pulses or double pulses are generated for each burst trigger signal: EXT INPUT or \*TRG command.

**Note**



---

Conflict  
<Period-Burst>  
If :PULSe:TIMing:PERiod < 5.00ns then  
:INPut:TRIGger:MODE BURSt is not allowed.

---

Related command: :PULSe:COUNT <value>|MIN|MAX

## **:INPut:TRIGger:MODE**

**:INPut:TRIGger:MODE ExternalWidth**

This command places the instrument into external width operating mode. Pulse width and period are controlled by a signal applied at the EXT INPUT.

All modes are common to channels 1 and 2 in dual channel instruments and cannot be set individually for each channel.

**Local Commands** AUTO, TRIG, GATE, BURST, E. WIDTH, and EXT INPUT

**Example** OUTPUT 711;":INP:TRIG:MODE AUTO"

---

## **:INPut:TRIGger:MODE?**

**Description** This command returns the current operating mode. The response is one of AUTO or TRIGGER or GATE or BURST or EWIDTH

**Local Commands** AUTO, TRIG, GATE, BURST, E. WIDTH, and EXT INPUT

**Example** OUTPUT 711;":INP:TRIG:MODE?"  
ENTER 711;A\$

---

**:INPut:TRIGger:SLOPe**

**Description** This command is used to set whether the instrument is triggered on the positive or negative slope of the input trigger signal.

**:INPut:TRIGger:SLOPe POSitive (Default)**

This command sets the instrument so that it is triggered on the positive edge of a pulse at the external input.

**:INPut:TRIGger:SLOPe NEGative**

This command sets the instrument so that it is triggered on the negative edge of a pulse at the external input.

Selecting both POS and NEG is not allowed.

**Local Commands** SLOPE, EXT INPUT

**Example** OUTPUT 711;":INP:TRIG:SLOP POS"

---

**:INPut:TRIGger:SLOPe?**

**Description** This command returns the edge of the pulse at the external input which is used to trigger the instrument. The response is either **POSITIVE** or **NEGATIVE**.

**Local Commands** SLOPE, EXT INPUT

**Example** OUTPUT 711;":INP:TRIG:SLOP?"  
ENTER 711; A\$

---

## :INPut:TRIGger:STATe

**Description** This command enables or disables triggering from the EXT INPUT connector.

:INPut:TRIGger:STATe OFF or :INPut:TRIGger:STATe 0 (Default)  
This command disables the external input. When this input is disabled trigger signals received by the instrument will have no effect.

:INPut:TRIGger:STATe ON or :INPut:TRIGger:STATe 1  
This command enables the external input. When this input is enabled trigger signals received by the instrument are effective.

The state is common to channels 1 and 2 in dual channel instruments, it cannot be set individually for each channel.

If a \*TRG command is processed, :STATE ON changes to :STATE OFF.

**Local Command** None.

**Example** OUTPUT 711; ":INP:TRIG:STAT ON"



**:INPut:TRIGger:STATe?**

---

**:INPut:TRIGger:STATe?**

**Description** This command returns the current state of the input trigger. The response is either **OFF** or **ON**. **OFF** indicates that the input trigger is disabled, **ON** indicates that the input trigger is enabled.

**Local Command** None.

**Example** OUTPUT 711;":INP:TRIG:STAT?"  
ENTER 711;A\$

---

## :INPut:TRIGger:THReshold

**Description** This command sets the threshold level of the input trigger signal at which the trigger is generated. The value can be set between -5.0 and +5.0 volts. The value should be specified in volts in an integer or decimal format, with or without the units (V). The default units (that is the units used when no units are explicitly defined) are volts. Selecting **MIN** will automatically set the threshold to -5.0V, selecting **MAX** will automatically set the threshold to 5.0V.

$-5.0 \leq \text{<value>} \leq 5.0$  or **MIN** or **MAX**

Specified Range: -5.0V to 5.0V

Resolution: 0.1V

Default: 0.0V

**Local Commands** THRE, EXT INPUT

**Example** OUTPUT 711;":INP:TRIG:THR 3.5V"

---

## :INPut:TRIGger:THReshold?

**Description** This command returns the current setting of the threshold value. The response is in decimal form, for example: 3.5. The units of the returned value are volts.

It is also possible to find the minimum or maximum possible threshold value of the instrument by the commands **THR MIN** and **THR MAX** respectively. These return the values -5.0 for the minimum and 5.0 for the maximum.

:INPut:TRIGger:THReshold?

**Local Commands**    THREE, EXT INPUT

**Example**            OUTPUT 711;":INP:TRIG:THR?"  
ENTER 711;A\$

---

**:OUTPut<channel>**

The OUTPut commands are channel specific and can be applied to either channel. The channel to which the command is being directed is specified by placing the channel number immediately after the OUTPut. This can be done in three ways.

- |         |  |
|---------|--|
| OUTPut  | (Default) When no channel is specified the command is directed to CHANNEL 1.                                   |
| OUTPut1 | The command is directed to CHANNEL 1.  |
| OUTPut2 | The command is directed to CHANNEL 2. These commands should only be used with an instrument with two channels. |

:INPut:TRIGger:THReshold?

:OUTPut:PULSe

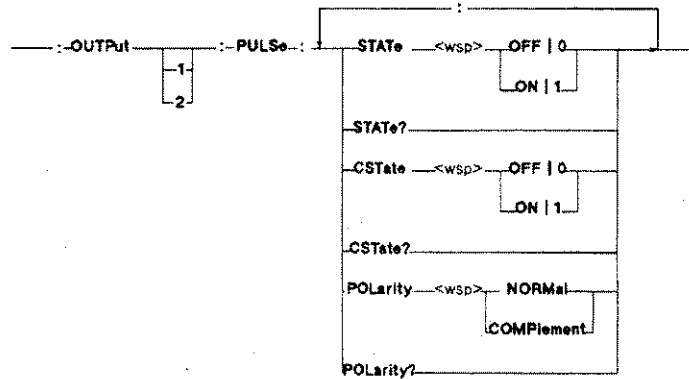

Figure 7-2. :OUTPut:PULSe Syntax Diagram

:OUTPut:PULSe:CState

**Description** This command enables or disables the OUTPUT.  
:OUTPut:PULSe:CState OFF or :OUTPut:PULSe:CState 0 (Default)  
The OUTPUT is disabled.  
:OUTPut:PULSe:CState ON or :OUTPut:PULSe:CState 1  
The specified channel's OUTPUT is enabled.  
OUTPUT is disabled at power-on and after a reset.

**Local Command** DISABLE

**Example** OUTPUT 711;":OUTP1:PULS:CState ON"

:OUTPut:PULSe:CState?

---

**:OUTPut:PULSe:CState?**

**Description** This command inquires about the current state of the OUTPUT. The response is either **OFF**, indicating that the OUTPUT is disabled, or **ON**, indicating that the OUTPUT is enabled.

**Local Command** DISABLE

**Example** OUTPUT 711;":OUTP1:PULS:CState?"  
ENTER 711;A\$

---

## :OUTPut:PULSe:POLarity

**Description** This command sets whether the output from the channel is inverted or not. This command applies to both the **OUTPUT** and **OUTPUT** signals simultaneously. In both cases (**NORM** or **COMP**) **OUTPUT** is the inverted form of **OUTPUT**.

:OUTPut:PULSe:POLarity **NORMAL** (Default)

The output signals are output as specified by the other setting parameters.

:OUTPut:PULSe:POLarity **COMPLEMENT**

The output signals are inverted with respect to the other setting parameters.

**Local Command** COMP

**Example** OUTPUT 711;":OUTP1:PULS:POL COMP"

---

## :OUTPut:PULSe:POLarity?

**Description** This command returns whether the output signals are as specified by the other setting parameters, or whether the signals are inverted. The response is either **NORMAL** or **COMPLEMENT**. When **COMPLEMENT** is returned it indicates that the outputs are in their inverted forms.

**Local Command** COMP

**Example** OUTPUT 711;":OUTP1:PULS:POL?"  
ENTER 711;A\$

---

**:OUTPut:PULSe:STATe**

**Description** This command enables or disables the OUTPUT.  
:OUTPut:PULSe:STATe OFF or :OUTPut:PULSe:STATe 0  
(Default)  
The OUTPUT is disabled.  
:OUTPut:PULSe:STATe ON or :OUTPut:PULSe:STATe 1  
The specified channel's OUTPUT is enabled.  
OUTPUT is disabled at power-on and after a reset.

**Local Command** DISABLE

**Example** OUTPUT 711;":OUTP1:PULS:STATe ON"

---

**:OUTPut:PULSe:STATe?**

**Description** This command inquires about the current state of the OUTPUT. The response is either OFF, indicating that the OUTPUT is disabled, or ON, indicating that the OUTPUT is enabled.

**Local Command** DISABLE

**Example** OUTPUT 711;":OUTP1:PULS:STATe?"  
ENTER 711;A\$

**:OUTPut:PULSe:STATe?**

---

**:PULSe" <channel>**

The **PULSe** commands are channel specific and can be applied to either channel. The channel to which the command is being directed is specified by placing the channel number immediately after the **PULSe**. This can be done in three ways.

- PULSe** (Default) When no channel is specified the command is directed to CHANNEL 1.
- PULSe1** The command is directed to CHANNEL 1.
- PULSe2** The command is directed to CHANNEL 2. These commands should only be used with an instrument with two channels.

---

**:PULSe:COUNT**

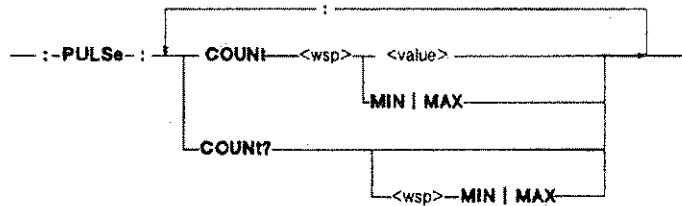

**Figure 7-3. :PULSe:COUNT Syntax Diagram**



---

**:PULSe:COUNT**

**Description** This command sets the number of pulses emitted for each trigger input in burst operating mode. The number of pulses can be from 1 through 9999. The count should be specified as an integer. You can also specify MIN, which sets the pulse count to 1, or MAX which sets the pulse count to 9999.

$1 \leq \text{<value>} \leq 9999$  or MIN or MAX  
Specified Range: 1 to 9999  
Resolution: 1  
Default: 1

The command :INPut:TRIG:MODE BURSt is closely related to this command.

**Local Command** COUNT

**Example** OUTPUT 711;":PULS:COUN 999"

---

**:PULSe:COUNT?**

**Description** This command returns the number of pulses contained in a burst. The response is in integer form, for example: 999.

**Local Command** COUNT

**Example** OUTPUT 711;":PULS:COUN?"  
ENTER 711;A\$

:PULSe:COUNT?

:PULSe:EDGE

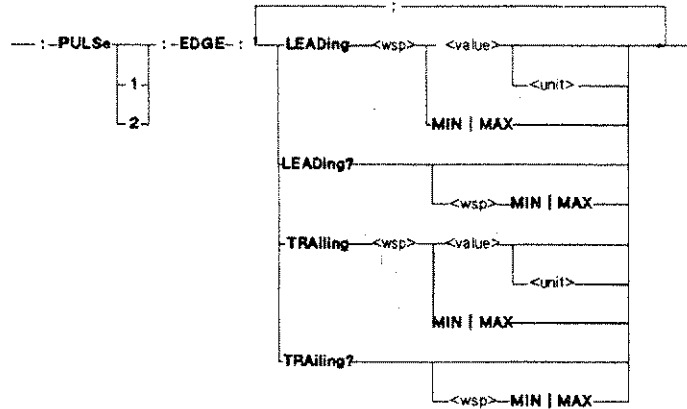

Figure 7-4. :PULSe:EDGE Syntax Diagram

:PULSe:EDGE:LEADing

**Description** This command sets the transition time for the leading edge of the pulse to rise from 10% to 90% of its amplitude. The leading edge of the pulse can be set from 670ps through 100 $\mu$ s. The value for the transition time is entered in seconds in integer, decimal or exponential form, with or without units. The default units (that is the units used when no units are explicitly defined) are seconds. You can also specify MIN, which sets the transition time to 1ns, or MAX, which sets the transition time to 100 $\mu$ s.

$670\text{E}-12 \leq \text{<value>} \leq 100\text{E}-3$  or MIN or MAX

Specified Range: 1ns to 100 $\mu$ s

Resolution: See Table 5-3

Default: 1.00 $\mu$ s

**:PULSe:EDGE:LEADing?**

**Note**



---

The leading and trailing edge transition times are related. See "LEAD" in Chapter 5 or "TRA" in Chapter 5 for the relationship.

---

**Local Command** LEAD

**Example** OUTPUT 711;":PULS:EDGE:LEAD 1.23MS" or  
OUTPUT 711;":PULS:EDGE:LEAD 1.23E-3"

---

**:PULSe:EDGE:LEADing?**

**Description** This command returns the leading edge transition time of the pulse. The response is the transition time in exponential format, for example 1.23E-3. The units of the returned value are seconds.

**Local Command** LEAD

**Example** OUTPUT 711;"PULS:EDGE:LEAD?"  
ENTER 711;A\$

---

## :PULSe:EDGE:TRAIling

### Description

This command sets the transition time for the trailing edge of the pulse to fall from 90% to 10% of its amplitude. The trailing edge of the pulse can be set from 670ps through 100 $\mu$ s. The value for the transition time is entered in seconds in integer, decimal or exponential format, with or without units. The default units (that is the units used when no units are explicitly defined) are seconds. You can also specify MIN, which sets the transition time to 1ns, or MAX, which sets the transition time to 100 $\mu$ s.

$670\text{E}-12 \leq \langle \text{value} \rangle \leq 100\text{E}-3$  or MIN or MAX  
Specified Range: 1ns to 100 $\mu$ s  
Resolution: See Table 5-3  
Default: 1.00 $\mu$ s

### Note



The leading and trailing edge transition times are related. See "LEAD" in Chapter 5 or "TRA" in Chapter 5 for the relationship.

### Local Command

TRA

### Example

OUTPUT 711;":PULS:EDGE:TRA 1.23MS" or  
OUTPUT 711;":PULS:EDGE:TRA 1.23E-3"

**:PULSe:EDGE:TRailing?**

**Description** This command returns the trailing edge transition time of the pulse. The response is the transition time in exponential format, for example 1.23E- 3. The units of the returned value are seconds.

**Local Command** TRA

**Example** OUTPUT 711;"PULS:EDGE:TRA?"  
ENTER 711;A\$

:PULSe:EDGE:TRAILing?

:PULSe:LEVel

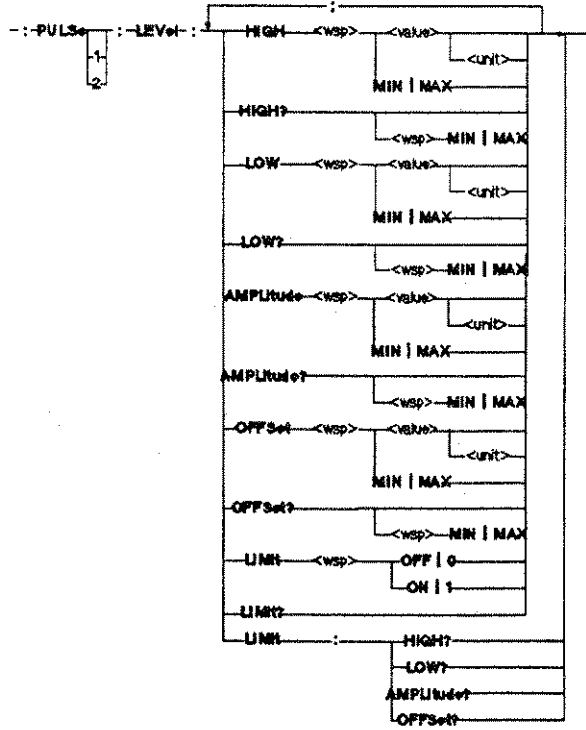

Figure 7-5. :PULSe:LEVel Syntax Diagram

:PULSe:LEVel:AMPLitude

**:PULSe:LEVel:AMPLitude?**

**Description** This command sets the amplitude of the output pulse. The amplitude can be set from 0.10V through 5.0V. The value can be specified, in volts, in an integer or decimal format, with or without the units. The default units (that is the units used when no units are explicitly defined) are volts. MIN or MAX can be specified. These set the amplitude to 0.10V and 5.0V respectively.

$0.10 \leq \langle \text{value} \rangle \leq 5.20$  or MIN or MAX

Specified Range: 0.10V to 5.00V

Resolution: 0.01V

Default: 1.00V

Amplitude and offset, and high level and low level are coupled.

Amplitude  $\equiv$  High Level - Low Level

Overvoltage Disabling: See "DISABLE" in Chapter 5.

**Local Command** AMPL

**Example** OUTPUT 711; ":PULS1:LEV:AMPL 2.10V"

---

**:PULSe:LEVel:AMPLitude?**

**Description** This command returns the amplitude setting of the output signal. The response is in decimal form, for example: 2.10. The units of the returned value are volts.

**Local Command** AMPL

**Example** OUTPUT 711; ":PULS1:LEV:AMPL?"  
OUTPUT 711;A\$

---

**:PULSe:LEVel:HIGH**

**Description** This command sets the high level of the output pulse. The high level can be set from -4.90V through 5.0V. The value can be specified, in volts, in an integer or decimal format, with or without the units. The default units (that is the units used when no units are explicitly defined) are volts. MIN or MAX can be specified. These set the amplitude to -4.90V and 5.00V respectively.

$-4.90 \leq \text{<value>} \leq 5.00$  or MIN or MAX

Specified Range: -5.10V to 5.20V

Resolution: 0.01V

Default: 0.50V

High level, low level, amplitude, and offset are coupled:  
High Level  $\equiv$  Offset + (Amplitude/2)

Overvoltage Disabling: See "DISABLE" in Chapter 5)

**Local Command** HIGH

**Example** OUTPUT 711; ":PULS1:LEV:HIGH 1.55V"

---

**:PULSe:LEVel:HIGH?**

**Description** This command returns the value of the output signal high level. The response is in decimal form, for example: 1.55. The units of the returned value are volts.



**:PULSe:LEVeL:HIGH?**

**Local Command**    HIGH

**Example**    OUTPUT 711;":PULS1:LEV:HIGH?"  
              ENTER 711;A\$

---

**:PULSe:LEVel:LIMit**

**Description**

This command enables or disables the output signal limit. Enabling the limit function makes the current high and low levels the limit levels. The levels of the output signal will not exceed these limits.

The high level, low level, amplitude, and offset commands are coupled commands and are processed before a limit enabling command within the same program message. When a limit has been enabled, high level, low level, amplitude and offset commands which are outside the limits set are ignored.

The high and low level limits are set as follows:

1. Disable the limit function if it is enabled.
2. Set the levels to the required limit values.
3. Enable the limit function.

:PULSe:LEVel:LIMit OFF or :PULSe:LEVel:LIMit 0  
(Default)

The limit function is disabled.

:PULSe:LEVel:LIMit ON or :PULSe:LEVel:LIMit 1

The limit function is enabled.

**Local Command**

LIMIT

**Example**

OUTPUT 711;":PULS:LEV:LIM ON"

**:PULSe:LEVel:LIMit?**

**Description** This command returns the current status of the limit function. The response is either **OFF**, if the limit function is disabled, or **ON** if the limit function is enabled.

**Local Command** LIMIT

**Example** OUTPUT 711;":PULS:LEV:LIM?"  
ENTER 711;A\$

---

**:PULSe:LEVel:LIMit:AMPLitude?**

**Description** This command returns the value of the output signal amplitude limit. The response is in decimal form, for example: 1.55. The units of the returned value are volts.

**Local Command** None.

**Example** OUTPUT 711;":PULS1:LEV:LIM:AMPL?"  
ENTER 711;A\$

---

**:PULSe:LEVel:LIMit:HIGH?**

**Description** This command returns the value of the output signal high level limit. The response is in decimal form, for example: 1.55. The units of the returned value are volts.

**Local Command** None.

**Example** OUTPUT 711;":PULS1:LEV:LIM:HIGH?"  
ENTER 711;A\$

---

**:PULSe:LEVel:LIMit:LOW?**

**Description** This command returns the value of the output signal low level limit. The response is in decimal form, for example: 1.55. The units of the returned value are volts.

**Local Command** None.

**Example** OUTPUT 711;":PULS1:LEV:LIM:LOW?"  
ENTER 711;A\$

:PULSe:LEVel:LIMit:OFFSet?

---

**:PULSe:LEVel:LIMit:OFFSet?**

**Description** This command returns the value of the output signal offset limit. The response is in decimal form, for example: 1.55. The units of the returned value are volts.

**Local Command** None.

**Example** OUTPUT 711;":PULS1:LEV:LIM:OFFS?"  
ENTER 711;A\$

---

**:PULSe:LEVel:LOW****Description**

This command sets the low level of the output pulse. The low level can be set from -5.00V through 4.90V. The value can be specified, in volts, in an integer or decimal format, with or without the units. The default units (that is the units used when no units are explicitly defined) are volts. MIN or MAX can be specified. These set the amplitude to -5.00V and 4.90V respectively.

$-5.20 \leq \langle \text{value} \rangle \leq 5.10$  or MIN or MAX

Specified Range: -5.00V to 4.90V

Resolution: 0.01V

Default: -0.50V

High level, low level, amplitude, and offset are coupled:

Low Level  $\equiv$  Offset - (Amplitude/2)

Overvoltage Disabling: See "DISABLE" in Chapter 5)

**Local Command**

LOW

**Example**

OUTPUT 711; ":PULS1:LEV:LOW 1.45V"

---

**PULSe:LEVel:LOW?****Description**

This command returns the value of the output signal low level. The response is in decimal form, for example: 1.45. The units of the returned value are volts.

PULSe:LEVel:LOW?

**Local Command**    LOW

**Example**            OUTPUT 711;":PULS1:LEV:LOW?"  
ENTER 711;A\$

---

**:PULSe:LEVel:OFFSet**

**Description** This command sets the offset of the output pulse. The offset can be set from -4.95V through 4.95V. The value can be specified, in volts, in an integer or decimal format, with or without the units. The default units (that is the units used when no units are explicitly defined) are volts. **MIN** or **MAX** can be specified. These set the offset to -4.95V and 4.95V respectively.

$-4.95 \leq \langle \text{value} \rangle \leq 4.95$  or **MIN** or **MAX**

Specified Range: -4.95V to 4.95V

Resolution: 0.01V

Default: 0.00V

Amplitude and offset, and high level and low level are coupled.

Offset  $\equiv$  (High Level + Low Level)/2

Overvoltage Disabling: See "DISABLE" in Chapter 5.

**Local Command** OFFS

**Example** OUTPUT 711;":PULS1:LEV:OFFS 2.10V"

---

**:PULSe:LEVel:OFFSet?**

**Description** This command returns the offset setting of the output signal. The response is in decimal form, for example: 2.10. The units of the returned value are volts.



:PULSe:LEVe:OFFSet?

OFFS

Example OUTPUT 711;":PULS1:LEV:OFFS?"  
OUTPUT 711;A\$

:PULSe:TIMing"

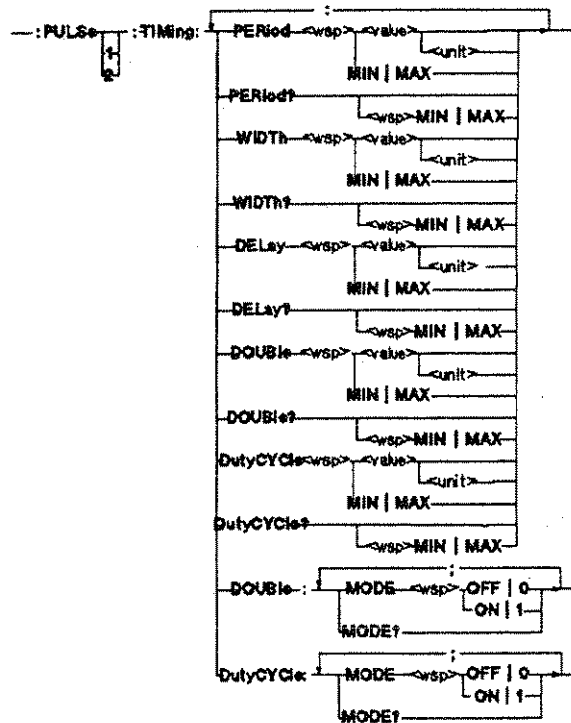

Figure 7-6. :PULSe:TIMing Syntax Diagram

---

## :PULSe:TIMing:DELAy

**Description** This command sets the delay time between the trigger (as output at the TRIG OUTPUT) and the start of the pulse. There is always a fixed delay between the trigger and the start of the pulse of 18ns, the value set here is added to this delay. The delay can be from 0.00ps to 99.9ms. The value for the delay is entered in seconds in integer, decimal or exponential form, with or without units. The default units (that is the units used when no units are specified) are seconds. MIN or MAX can also be specified, these set the values 0.00ps and 99.9ms respectively.

$0.00 \leq \langle \text{value} \rangle \leq 99.9$  or MIN or MAX

Specified Range: 0.00ps to 99.9ms

Resolution: See Table 5-3.

Default: 0.00ps

Fixed delay (from the trigger output to the differential outputs): 18ns

### Note



#### Conflict

$\langle \text{Period-Delay} \rangle$

See Table 5-1 or Table H-5 for a description of the timing relationships.

There is another closely related command to this one. This is :PULS:TIM:DOUB:MODE OFF|ON where OFF enables delay and disables double pulse and ON enables double pulse and disables delay.

**Local Command** DELAY

**Example** OUTPUT 711;":PULS1:TIM:DEL 11.1E-9" or  
OUTPUT 711;":PULS1:TIM:DEL 11.1ns"

**:PULSe:TIMing:DELay?**

**Description** This command returns the value currently set for the delay parameter. The response is in exponential form, for example: 11.1E-9. The units of the returned value are seconds.

**Local Command** DELAY

**Example** OUTPUT 711;":PULS:TIM:DEL?"  
ENTER 711;A\$

---

## :PULSe:TIMing:DOUBle

**Description** This command sets the delay time between the first and second pulse in double pulse mode. The delay can be from 3.00ns to 99.9ms. The value for the delay is entered in seconds in integer, decimal or exponential form, with or without units. The default units (that is the units used when no units are specified) are seconds. **MIN** or **MAX** can also be specified, these set the values 2.00ns and 99.9ms respectively.

$3.00 \leq \langle \text{value} \rangle \leq 99.9$  or **MIN** or **MAX**  
Specified Range: 3.33ps to 99.9ms  
Resolution: See Table 5-3.  
Default: 200 $\mu$ s

### Note



---

**Conflict**  
<Period-Double>  
See Table 5-2 or Table H-5 for a description of the timing relationships.

---

:PULS:TIM:DCYC:MODE OFF|ON is related to this command. If DCYC is inactive then the pulse width is set directly by the WIDTH command. If DCYC is active then the pulse width is given by PERIOD\*DCYC/200.

There is another closely related command to this one. This is :PULS:TIM:DOUB:MODE OFF|ON where OFF enables delay and disables double pulse and ON enables double pulse and disables delay.

**Local Command** DOUBLE

**Example** OUTPUT 711;":PULS1:TIM:DOUB 11.1E-9" or  
OUTPUT 711;":PULS1:TIM:DOUB 11.1ns"

---

**:PULSe:TIMing:DOUBle?**

**Description** This command returns the value currently set for the double pulse delay parameter. The response is in exponential form, for example: 11.1E-9. The units of the returned value are seconds.

**Local Command** DOUBLE

**Example** OUTPUT 711;":PULS:TIM:DOUB?"  
ENTER 711;A\$

---

**:PULSe:TIMing:DOUBle:MODE**

**Description** This command selects whether the channel is in double pulse mode or pulse delay mode. The two modes are mutually exclusive, pulse delay (delay of the first pulse) with respect to trigger is not available in the double pulse mode.

:PULSe:TIMing:DOUBle:MODE OFF or  
:PULSe:TIMing:DOUBle:MODE 0 (Default)  
Pulse delay is selected.

:PULSe:TIMing:DOUBle:MODE ON or  
:PULSe:TIMing:DOUBle:MODE 1  
Double pulse is selected

**Local Commands** DOUBLE, DELAY

**Example** OUTPUT 711;":PULS1:TIM:DOUB:MODE ON"

---

## :PULSe:TIMing:DOUBle:MODE?

**Description** This command indicates whether double pulse or pulse delay operation is currently enabled. The response is either **OFF**, if pulse delay operation is enabled, or **ON**, if double pulse operation is enabled.

**Local Command** DOUBLE, DELAY

**Example** OUTPUT 711; ":PULS1:TIM:DOUB:MODE?"  
ENTER 711;A\$

---

## :PULSe:TIMing:DutyCYcle

**Description** This command sets the duty cycle of the pulse. This is a percentage value input in integer form, with or without units. Alternatively **MIN** or **MAX** can be input, these set the duty cycle to 1% and 90% respectively. The units for percentage are expressed by **PCT**.

$1 \leq \langle \text{value} \rangle \leq 99$  or **MIN** or **MAX**  
Specified Range: 1% to 90%  
Resolution: 1%  
Default: 50%

**Note**



---

**Conflict**  
<Period-DCYC>  
<Double-DCYC>  
See Table 5-1 or Table H-5 for a description of the timing relationships.

---

**Local Command** DCYC

**Example** OUTPUT 711;":PULS1:TIM:DCYC 11PCT"

---

## :PULSe:TIMing:DutyCYcle?

**Description** This command returns the duty cycle. It is returned in integer format, for example: 11. The returned value is a percentage.

**:PULSe:TIMing:DutyCYcle?**

**Local Command** DCYC

**Example** OUTPUT 711;":PULS1:TIM:DCYC?"  
ENTER 711;A\$

---

## **:PULSe:TIMing:DutyCYcle:MODE**

**Description** This command selects between the duty cycle or width parameters to determine the on-time of the pulse.

If Double pulse is inactive then Pulse width =  
 $PERIOD * DCYC / 100$

If Double pulse is inactive then Double pulse width =  
 $PERIOD * DCYC / 200$

**Note**



**Conflict**

<Trigger-DCYC>

:INP:TRIG:MODE TRIG and :PULS:TIM:DCYC:MODE ON are incompatible.

---

:PULSe:TIMing:DutyCYcle:MODE OFF or

:PULSe:TIMing:DutyCYcle:MODE 0 (Default)

Duty Cycle is disabled. The pulse width or double pulse width is specified by the WIDTH parameter.

:PULSe:TIMing:DutyCYcle:MODE ON or

:PULSe:TIMing:DutyCYcle:MODE 1

Duty cycle is enabled.

**Local Commands** DCYC, WIDTH

**Example** OUTPUT 711;":PULS1:TIM:DCYC:MODE ON"



**:PULSe:TIMing:DutyCYCle:MODE?**

**Description** This command returns whether the pulse on-time is decided by the duty cycle or the width parameter. The response is one of **OFF** or **ON**. **OFF** indicates that the on-time is determined by the width, **ON** indicates that the on-time is calculated from the duty cycle and the period.

**Local Commands** DCYC, WIDTH

**Example** OUTPUT 711:":PULS1:TIM:DCYC:MODE?"  
ENTER 711;A\$

---

## :PULSe:TIMing:PERiod

**Description** This command sets the period of the output signal during in the automatic, burst and gate operating modes. In the trigger and external width operating modes the period is controlled by the EXT INPUT signal. The period can be set between 3.33ns and 99.9ms. The value is input as in integer, decimal or exponential format, with or without units. The default units (that is, those units used when no units are explicitly input) are seconds. Alternatively you can input MIN or MAX, these set the period to 2.00ns and 99.9ms respectively.

$3.00\text{ns} \leq \langle \text{value} \rangle \leq 99.9\text{ms}$  or MIN or MAX

Specified Range: 3.33ns to 99.9ms

Resolution: See Table 5-3.

Default: 1.00ms

The period parameter is common to Channels 1 and 2 in dual channel instruments. It cannot be set individually for each channel.

### Note



Conflict

<Period-Burst>

<Period-Width>

<Period-Delay>

<Period-DCYC>

<Period-DOUB>

See Table 5-1, Table 5-2 or Table H-5 for a description of the timing relationships.

**Local Command** PERIOD

**Example** OUTPUT 711;":PULS2:TIM:PER 1.11E-3" or  
OUTPUT 711;":PULS2:TIM:PER 1.11ms"

**:PULSe:TIMing:PERiod?**

---

**:PULSe:TIMing:PERiod?**

**Description** This command returns the value set for the period of the output signal. The response is in exponential form, for example 1.11E-3. The units of the returned value are seconds.

**Local Command** PERIOD

**Example** OUTPUT 711;":PULS2:TIM:PER?"  
ENTER 711;A\$

---

**:PULSe:TIMing:WIDTh**

**Description** This command sets the on-time of the pulse. The value can be from 1.00ns to 99.9ms. The value is input in seconds in integer, decimal or exponential form, with or without units. The default units (that is, the units used when no units are explicitly input) are seconds.

$1.00\text{ns} \leq \langle \text{value} \rangle \leq 99.9\text{ms}$  or MIN or MAX  
Specified Range: 1.50ns to 99.9ms  
Resolution: See Table 5-3.  
Default: 100 $\mu\text{s}$

**Note**  **Conflict**  
<Period-Width>  
<Width-Double>  
See Table 5-1 or Table H-5 for a description of the timing relationships.

**Local Command** WIDTH

**Example** OUTPUT 711;":PULS1:TIM:WIDT 111E-6" or  
OUTPUT 711;":PULS1:TIM:WIDT 111 $\mu\text{s}$ "

---

**:PULSe:TIMing:WIDTh?**

**Description** This command returns the setting for the width of the pulse. The response is in exponential form, for example: 111E-6. The units of the response are seconds.

:PULSe:TIMing:WIDTh?

Local Command WIDTH

Example OUTPUT 711;":PULS1:TIM:WIDT?"  
ENTER 711;A\$

:SYSTem

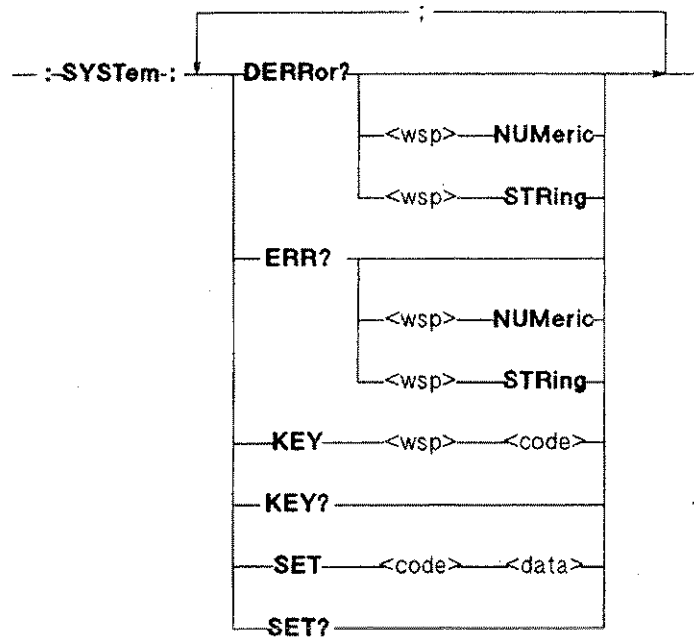

Figure 7-7. :SYSTem Syntax Diagram

---

## **:SYSTem:DERRor?**

**Description** This command returns device dependent errors.  
See Chapter 3 for additional information.  
Table H-4 contains a list of errors reported by the :DERR? query.  
Error code 0 = no errors.

**:SYSTem:DERRor? (Default)**  
Device dependent error codes are returned, for example, -100.

**:SYSTem:DERRor? NUMeric**  
Device dependent error codes are returned, for example, -100.

**:SYSTem:DERRor? STRing**  
Device dependent error codes are returned plus a brief description of the error, for example, -100, <Period - Width Ch. 1>.

**Local Command** None.

**Example**

```
DIM A$ [5000]
OUTPUT 711;":SYST:DERR?" or
OUTPUT 711;":SYST:DERR? NUM" or
OUTPUT 711;":SYST:DERR? STR"
ENTER 711;A$
```

---

**:SYSTem:ERRor?**

**Description** This command returns an error code, the error queue is organized is a First-In, First-Out (FIFO) queue, this means that it is always the oldest error in the queue which is returned. Only one error is returned per query.

Table H-3 contains a list of errors reported by the :ERR? query.

Error code 0 = no errors

:SYSTem:ERRor? (Default) The error code is returned, for example, -350.

:SYSTem:ERRor? NUMeric  
The error code is returned, for example, -350.

:SYSTem:ERRor? STRing  
The oldest error code plus a brief description of the error is returned, for example, -350, <Too Many Errors>.

**Local Command** None.

**Example**

```
DIM A$ [1000]
OUTPUT 711; ":SYST:ERR?" or
OUTPUT 711; ":SYST:ERR? NUM" or
OUTPUT 711; ":SYST:ERR? STR"
ENTER 711;A$
```

**:SYSTem:KEY <code>**

The :KEY command simulates the pressing of a front panel key. The code following the command indicates the key to be simulated, it is a 16 bit integer value. The codes are listed in the table below.

**Table 7-5. :SYSTem:KEY Codes**

Code	Key	Code	KEY
1	RANGE down	2	RANGE up
3	VERNIER 1 down	4	VERNIER 1 up
5	VERNIER 10 down	6	VERNIER 10 up
7	VERNIER 100 down	8	VERNIER 100 up
<b>RIGHT CHANNEL(single or dual channel instruments)</b>			
9	WIDTH/DCYC	10	LEAD
11	TRA	12	HIGH/AMPL
13	DISABLE (normal)	14	LIMIT
15	COMP	16	DISABLE (complement)
25	LOW/OFFS	27	DEL/DOUB
<b>LEFT CHANNEL (dual channel instruments only)</b>			
17	WIDTH/DCYC	18	LEAD
19	TRA	20	HIGH/AMPL
21	DISABLE (normal)	22	LIMIT
23	COMP	24	DISABLE (complement)
29	LOW/OFFS	31	DEL/DOUB
<b>CHANNEL INDEPENDENT</b>			
33	MEM	34	SAV
35	RCL	36	positive slope
37	negative slope	38	THRE
39	MAN	40	1 PULSE
41	SET	42	none
43	none	44	MODE
45	LCL (address)	46	PERIOD/COUNT



**:SYSTem:KEY?**

**Local Commands** All.

**Example** OUTPUT 711;":SYST:KEY 13"

---

**:SYSTem:KEY?**

**Description** This command returns the code of the last key pressed on the front panel. The response is in integer format, for example: 13.

Only real key presses are recorded in the key queue, key presses simulated by the :SYSTem:KEY command are not recorded.

If the queue is empty, an ASCII zero (0) is returned.

The codes are listed in Table 7-5 below.

See Chapter 3 for additional information.

**Local Command** None.

**Example** OUTPUT 711;":SYST:KEY?"  
ENTER 711;A\$

---

**:SYSTem:SET <data>**

**Description** This command transfers the setting information for the instrument in the form of a string of binary data.

**Local Command** None.

**Note**  :SYSTem:SET is not related to the local function SET.

**Example** See the example for the application of :SYST:SET?.

---

**:SYSTem:SET?**

**Description** This command returns the current setting of the instrument. The response is in the form of binary data.  
The block of data is identical to the block of data saved and recalled by the \*SAV and \*RCL commands.

**Local Command** None.

**Example**

```
10 DIM Query$[100],Setting$[200]BUFFER
20 !
30 ASSIGN @Hpib_device TO 711
40 ASSIGN @Path TO BUFFER Setting$
50 !
60 !Read current setting from the HP 8130A
70 Query$=":SYST:SET?"
80 GOSUB Fetch
90 !
100 !Write stored setting to the HP 8130A
```

**:SYSTEM:SET?**

```
110 Count_out=176
120 GOSUB Write
130 !
140 STOP
150 !
160 Fetch: !
170 Output @Hpib_device;Query$
180 TRANSFER @Hpib-device TO @Path;END, WAIT
190 RETURN
200 !
210 Write: !
220 TRANSFER @Path TO @Hpib_device;
COUNT count_out, WAIT
230 RETURN
240 !
250 END
```



## **Installation and Maintenance**

---

### **Safety Considerations**

The Model HP 8130A is a Safety Class 1 instrument (instrument with an exposed metal chassis that is directly connected to earth via the power supply cable). The symbol used to indicate a protective earth terminal in the instrument is .

Before operation, the instrument and manual, including the red safety page, should be reviewed for safety markings and instructions. These must then be followed to ensure safe operation and to maintain the instrument in safe condition.

Power is supplied to some of the HP 8130A circuits at any time that the instrument is connected to the AC power source.

To disconnect from the line power, disconnect the power cord either at the rear power-inlet or at the AC line-power source (receptacle). One of these must be accessible at all times. If the instrument is installed in a cabinet, it must be disconnected from the line power by means of the system's line-power switch.

---

### **Initial Inspection**

Inspect the shipping container for damage. If the container or cushioning is damaged, it should be kept until the contents of the shipment have been checked for completeness and the instrument has been verified both mechanically and electrically.

Procedures for checking the operation of the instrument are given in the Performance Tests. If the contents are incomplete, mechanical damage or defect is apparent, or if an instrument does not pass the operator's checks,

notify the nearest Hewlett-Packard office. Keep the shipping materials for carrier's inspection. The HP office will arrange for repair or replacement without awaiting settlement.

---

**Warning**

**To avoid hazardous electrical shock, do not perform electrical tests when there are signs of shipping damage to any portion of the outer enclosure (covers, panels, etc.).**

---

---

**Power Requirements****Caution**

Before applying AC line power to the HP 8130A, ensure that the voltage selector on rear panel of the HP 8130A is set for the proper line voltage and the correct line fuse is installed in the fuse holder. Procedures for changing the line voltage selector and fuse are contained in the following section "Line Voltage Selection".

---

The HP 8130A can operate from any single-phase AC power source supplying 100 V, 120 V, 220 V or 240 V in the frequency range from 50 to 60 Hz (see Table A-1). The maximum power consumption is 250 VA with all options installed.

**Table A-1. Line Voltage Ranges**

Selector Voltage	AC Voltage Range
100	90 - 110 V
120	108 - 132 V
220	198 - 242 V
240	216 - 264 V

---

## Line Voltage Selection

---

**Caution**

BEFORE SWITCHING ON THE INSTRUMENT, make sure that the instrument is set to the local line voltage and the correct line fuse is installed in the fuse holder.

---

The line voltage selector is set at the factory to correspond to the most commonly used line voltage of the country of destination. The switch is combined with the power line voltage receptacle on the rear panel. Refer to Table A-1 for the line voltage ranges and Table A-2 to set the line voltage and select the appropriate fuse.

**Table A-2. Line Voltage and Fuse Selection**

Line Voltage	Fuse Type	HP Part Number
100 V / 120 V	T 3A, 250 V	2110-0029
220 V / 240 V	T 1.5A, 250 V	2110-0304

To change the line voltage and fuse:

1. Remove the power cord.
2. Insert a screwdriver into the recess at the side of the assembly.
3. To change the voltage setting, the selector must be removed and then replaced with the new setting value displayed.
4. If necessary, change the fuse in accordance with the new voltage setting.

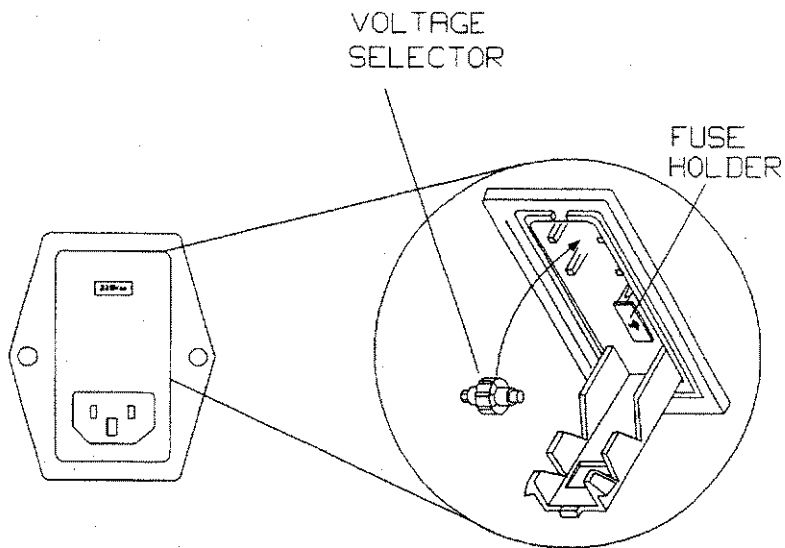

**Figure A-1. Line Voltage Switch Assembly**

---

## Power Cable

In accordance with international safety standards, this instrument is equipped with a three-wire power cable. When connected to an appropriate AC power receptacle, this cable grounds the instrument cabinet. The type of power cable shipped with each instrument depends on the country of destination. Refer to Figure A-2 for the part numbers of the power cables available.

---

### Warning



To avoid the possibility of injury or death, the following precautions must be followed before the instrument is switched on.

- If this instrument is to be energized via an autotransformer for voltage reduction, ensure that the **Common terminal** is connected to the grounded pole of the power source.
- The power cable plug shall only be inserted into a socket outlet provided with a protective ground contact. The



protective action must not be negated by the use of an extension cord without a protective conductor.

- Before switching on the instrument, the protective ground terminal of the instrument must be connected to a protective conductor. This is verified by using the power cord which is supplied with the instrument.
- Intentional interruption of the protective ground connection is prohibited.

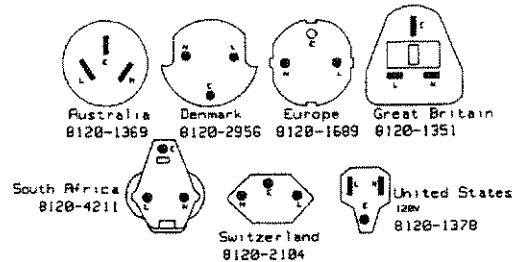

**Figure A-2. Power Cables - Plug Identification**

The following work should be carried out by a qualified electrician - all local electrical codes being strictly observed. If the plug on the cable does not fit the power outlet, or the cable is to be attached to a terminal block, cut the cable at the plug end and re-wire it.

The color coding used in the cable will depend on the cable supplied. If a new plug is to be connected, it should meet local safety requirements and include the following features:

- Adequate load-carrying capacity (see table of specifications).
- Ground connection.
- Cable clamp.

---

## Operating Environment

The following summarizes the HP 8130A operating environment ranges. In order for the HP 8130A to meet specifications, the operating environment must be within these limits.

---

### Warning



**The HP 8130A is not designed for outdoor use. To prevent potential fire or shock hazard, do not expose the HP 8130A to rain or other excessive moisture.**

---

### Temperature

The HP 8130A may be operated in temperatures from 0°C to 55°C.

### Humidity

The HP 8130A may be operated in environments with humidity up to 95% (0°C to +40°C). However, the HP 8130A should be protected from temperatures or temperature changes which cause condensation within the instrument.

---

## Instrument Cooling

The HP 8130A is equipped with a cooling fan mounted inside the rear panel. The instrument should be mounted so that air can freely circulate through it. When operating the HP 8130A, choose a location that provides at least 75 mm (3 inches) of clearance at the rear, and at least 25 mm (1 inch) of clearance at each side. Failure to provide adequate air clearance will result in excessive internal temperature, reducing instrument reliability.

---

## Storage and Shipment

The instrument can be stored or shipped at temperatures between  $-40^{\circ}\text{C}$  and  $+75^{\circ}\text{C}$ . The instrument should be protected from temperature extremes which may cause condensation within it.

---

## HP-IB Interface

### Networks

The network may be:

- A star network
- A linear network
- A combination star and linear network.

Limitations:

- The total cable length cannot exceed 20 meters
- The maximum cable length per device is 2 meters
- No more than 15 devices may be interconnected on one bus.

---

### Caution



- It is recommended that no more than three connectors be stacked one on top of the other.
- Hand tighten the connector lock screws. Do not use a screwdriver.

---

### Cables and Adapters

The HP-IB connector is compatible with the connectors on the following cables and adapter.

- HP-IB Cable, 10833A, 1 m (3.3 ft.)
- HP-IB Cable, 10833B, 2 m (6.6 ft.)

- HP-IB Cable, 10833C, 4 m (13.2 ft.)
- HP-IB Cable, 10833D, 0.5 m (1.6 ft.)
- HP-IB Adapter, 10834A, 2.3 cm. extender.

## Connector

The following figure shows the connector and pin assignments.

Connector Part Number: 1251-0293

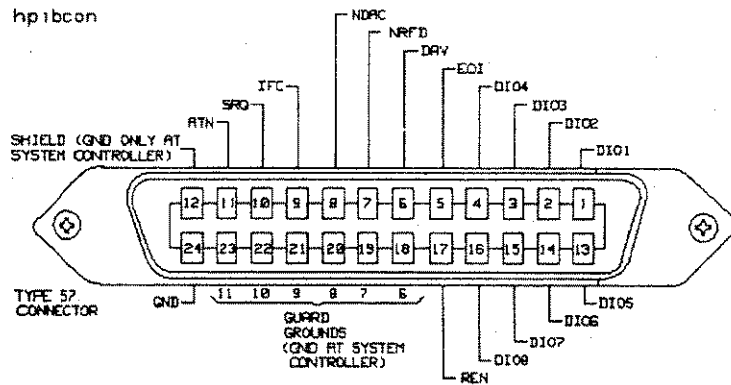

Figure A-3. HP-IB Connector

## Connector Lock Screw Compatibility

### Caution



HP products delivered now are equipped with connectors having ISO metric-threaded lock screws and stud mounts (ISO M3.5x0.6) which are black in color.

Earlier connectors may have lock screws and stud mounts with English-threaded lock screws and stud mounts (6-32 UNC) which have a shiny nickel finish.

---

## **Mounting Hardware**

See Appendix D.

---

## **Preventative Maintenance**

None required.

---

## **Customer Self Service**

The Service Manual will contain the following service information:

- Performance Tests
- Adjustment Procedures
- Theory and schematics
- Replaceable Parts List.

---

## **HP Service**

HP offers the following services:

- Performance Testing
- Adjustment
- Repair
- Calibration



## Specifications

---

### Specifications

Specifications describe the instruments warranted performance. Non-warranted values are described as “typical”.

All specifications apply after a 30 minute warm-up phase with 50Ω load resistance at all outputs, and are valid at ambient temperatures in the range 0°C to 55°C.

### Error Detection

An error display indicates that a programmed setting exceeds the specified range, and that the output may be invalid. If the limiting condition is important in the application the output should be verified on an oscilloscope. In other cases, the timing should be adjusted until the error display turns off, indicating that all outputs are valid.

**Table B-1.**  
**Maximum Values of WIDTH, DCYC, and DELAY versus PERIOD**

PERIOD(ns)	On-Time	DELAY
3.33 ... 4.99	0.5×PERIOD	0.5×PERIOD-1ns
5.00 ... 19.9	0.7×PERIOD-1ns	0.7×PERIOD-2ns
≥ 20.0	0.9×PERIOD-5ns	0.9×PERIOD-6ns

### Note



On-Time in this table refers to the value set by DCYC (duty cycle) as well as by WIDTH.

**Table B-2. Maximum Values of DOUB versus PERIOD**

PERIOD(ns)	DOUB
3.33 ... 7.19	n/a
7.20 ... 9.99	0.5×PERIOD
≥ 10.0	0.9×PERIOD-4ns

### Timing Parameters

#### Common Specification: Measurement Conditions:

Automatic operating mode, measured at 50% of amplitude and using the fastest transition times.

**Resolution:** 3 digits, best case: 10ps.

**Repeatability:** Factor of 4 better than accuracy.

**RMS-Jitter:** 0.025% of programmed value + 15ps (0.05% of programmed value +15ps for the range from 10ns to 100ns)

#### Period

**Range:** 3.33ns to 99.9ms

**Accuracy:** ±5% of programmed value ±100ps

#### Width

**Range:** 1.5ns to 99.9ms (See Table B-1 for the maximum)

**Accuracy:** ±5% of programmed value ±250ps.

### B-2 Specifications



**Delay**

This value is measured between the trigger output at TRIG OUTPUT and the pulse at OUTPUT or OUTPUT.

Double Pulse and Delay are mutually exclusive.

**Fixed Delay:** 18ns

**Variable Range:** 0ns to 99.9ms (See Table B-1 for maximum)

**Accuracy:**  $\pm 5\%$  if programmed value  $\pm 1.5\text{ns}$ .

**Double Pulse**

Period  $\geq 7.20\text{ns}$

Double Pulse and Delay are mutually exclusive.

**Range:** 3.33ns to 99.9ms (see Table B-2 for maximum)

**Accuracy:**  $\pm 5\%$  of programmed value  $\pm 250\text{ps}$

### Transition Times

These are measured at 10% to 90% of amplitude

**Range:** 1ns to 100 $\mu$ s

The range at 20% to 80% of amplitude has a typical lower limit of 600ps.

Leading and trailing edges are independently programmable within the following ranges

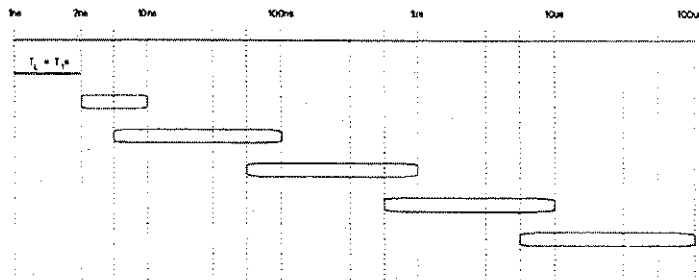

\* Leading and trailing edges are assigned the same value.

**Accuracy:**  $\pm 10\%$  of programmed value  $\pm 300$ ps

### B-4 Specifications

**Linearity:.**

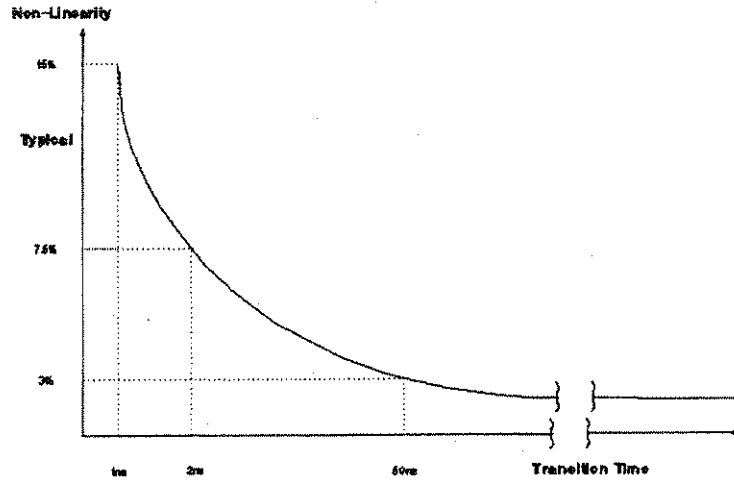

**Maximum values:.** Conflict with other timing parameters may cause amplitude clipping and is indicated by the "Excessive" display.

**Output Levels**

Output levels double when driving into open circuits. The instrument disables outputs if levels exceed  $\pm 6.5V$  or if the amplitude exceeds  $6.5V_{p-p}$ .

**Measurement Conditions**

**Resolution:** 3 Digits, best case: 10mV.

**Level Accuracy:**  $\pm 1\%$  of programmed value  $\pm 3\%$  of amplitude  $\pm 40mV$

**Repeatability:** Factor of 4 better than accuracy

**Settling Time:** 20ns (at the fastest transition time)

**High Level**

-4.90V to +5.00V

**Low Level**

-5.00V to +4.90V

**Pulse Performance**

**Overshoot:**  $\leq 10\%$  of amplitude  $\pm 20mV$

**Ringing:**  $\leq 10\%$  of amplitude  $\pm 20mV$

**Preshoot:**  $\leq 5\%$  of amplitude  $\pm 20mV$



---

## **Operating Characteristics**

Operating characteristics describe typical, non-warranted performance.

### **Timing Parameters**

#### **Duty Cycle**

Width and duty cycle are mutually exclusive

**Range:** 1% to 90%

**Resolution:** 1% Subject to width and period specifications

## Inputs and Outputs

All inputs and outputs have BNC connectors on the front panel. Rear panel connectors are optional.

### Main Outputs

These are differential outputs.

**Amplitude:** 100mVp-p to 5Vp-p into 50Ω

For pulse widths less than settling time, the amplitude may decrease by 10% of the programmed value.

**Offset:** -4.95V to 4.95V into 50Ω

**Source Impedance:** 50Ω ±1Ω

**Maximum External Voltage:** ±5V

**Short Circuit Current (I<sub>SC</sub>):** -200mA ≤ I<sub>SC</sub> ≤ +200mA

**Skew:** The skew between differential outputs of the same channel <100ps

### External Input

This input is used in trigger, gate, burst, and external width operating modes. Trigger slopes can be selected positive or negative.

**Input Impedance:** 50Ω ±2.5Ω

**Threshold:** -5V to +5V

**Resolution:** 100mV

**Maximum Input Voltage:** ±10V

**Input Transition:** <50ns

**Input Frequency:** dc to 300MHz

**Minimum Pulse Width:** 1.5ns

**Input Sensitivity:** ≥300mVp-p

### Trigger Output

**Levels:** High at 2.4V, low at 0.3V into 50Ω

**Trigger Pulse Width:**

Period	Pulse Width
3.33ns to 99.9ns	50% of Period
100ns to 999ns	95% of Period
1.00μs to 9.99μs	99.5% of Period
10.0μs to 99.9ms	99.95% of Period

**Transition Times:** <1ns

**Source Impedance:** 50Ω ±2.5Ω

**Delay:** From external input to trigger output

In trigger and external width operating mode: 16ns

In Gate and burst operating mode: 18.5ns

**Max/Min External Voltage:** +7/-2V

### Trigger Modes

**Manual:** Simulates an external input signal.

**1 Pulse:** In trigger gate and burst operating mode one pulse or double pulse is generated.

**Auto:** Continuous pulse stream

**Trigger:** Each active input transition generates a single output pulse or double pulse

**Gate:** External signal enables period generator. The first output pulse is synchronous with active edge. The last pulse is always completed. The width and period of the first pulse may deviate 10% from subsequent pulses.

**External Burst.** Each active input transition generates a preprogrammed number of pulses (1 to 9999). The minimum burst period is 5ns. The width and period of the first pulse may deviate 10% from subsequent pulses.

**External Width.** Pulse recovery, the external edges toggle the output. Output levels and transition times can be selected.



## **Output Capabilities**

### **Limit**

The maximum high and low levels into 50 $\Omega$  can be limited to protect the device under test.

### **Complement**

Normal or complemented outputs can be selected.

### **Disable**

Relays are used to connect or disconnect the outputs.

### **Set**

This function will set the parameters to fixed ratio relative to period. (Delay = 0ns; width = 50% of period; transitions - 10% of period, limited to 1ns; period, high level and low level = current values).

---

## **Additional Features**

### **HP-IB capabilities**

All modes and parameters are programmable , downloadable and uploadable. ASCII and binary formats are supported.

### **HP-IB Interface Code:**

SH1, AH1, T6, TE0, L4, LE0, SR1, RL1, PP0, DC1, DT1, C0.

### **Non-Volatile Memory**

Current settings are saved on power-down. Additionally, 19 complete set-ups can be stored.

---

## General Environmental

### Storage Temperature

-40°C to +65°C

### Operating Temperature

0°C to 55°C

### Humidity

(0°C to 40°C):95% R.H.

### Power

100/200/220/240 Vrms, ±10%

250VA max.

50-60Hz

### Weight

Net: 20kg (44.4lb)

Shipping: 28kg (62.2lb)

### Dimensions

(H × W × D): 145mm × 426mm × 525mm (5.70in × 16.75 × 20.65in.)

### Recalibration Period:

1 year recommended.

## B-12 Specifications



## **Performance Tests**

---

### **Introduction**

The performance tests verify the instruments specified performance characteristics.

They are suitable for incoming inspection, preventative maintenance, troubleshooting, and final test.

Make the Performance Tests in the order of occurrence in the manual.

Recommended test equipment is listed in Table 1.

---

### **Safety**

The HP 8130A is a Safety Class 1 instrument. It has an exposed metal chassis that is directly connected to earth potential through the line power cord.

Before testing the instrument review:

1. The Safety Summary (red page)
2. The Instrument Reference Manuals
3. The instrument safety markings.

---

## Test Record

A test record is located at the end of this chapter.

The test results are identified as *TR Entries* in the performance tests and on the test record.



---

## Period Test

### Specifications

Range: 3.33ns to 99.9ms

Resolution: 3 digits (best case: 10ps)

Accuracy: 5% of programmed value  $\pm 100$ ps

rms Jitter: 10ns to 100ns range: 0.05% of progr. value

+15ps

all other ranges: 0.025% of programmed value

+15ps

Repeatability: Factor 4 better than accuracy

### Equipment

1. Counter.
2. Cable, 50 $\Omega$ , BNC to BNC, coaxial.

### Set-Up

1. Connect the IIP 8130A's OUTPUT 1/2 to the Counter's channel A input (HP5335A)  
FREQ input (HP5370B).
2. Set the HP 8130A:

MODE	AUTO		Option 020
TIMING	PERIOD	: 2.00ns	
	DEL	: 0ns	0ns
	DCYC	: 50%	50%
	LEAD	: 1.00ns	1.00ns
	TRA	: 1.00ns	1.00ns
OUTPUT	HIGH	: +1.5V	+1.5V
	LOW	: -1.5V	-1.5V
	ENABLE		DISABLE

3. Set Counter:

- a. Function = PERIOD
- b. Channel A = 50Ω
- c. Trigger Level = Preset

**Procedure**

Check the HP 8130A period at the following settings:



<b>Period</b>	<b>Acceptable</b>	<b>Range</b>	<b>TR Entry</b>
3.33ns†	3.06ns	3.56ns	1-1
5.00ns	4.65ns	5.35ns	1-2
10.0ns	9.4ns	10.6ns	1-3
50.0ns	47.4ns	52.6ns	1-4
100ns	94.9ns	105.1ns	1-5
500ns	474.9ns	525.1ns	1-6
1.00μs	949.9ns	1.05μs	1-7
5.00μs	4.75μs	5.25μs	1-8
10.0μs	9.5μs	10.5μs	1-9
50.0μs	47.5μs	52.5μs	1-10
100μs	95μs	105μs	1-11
500μs	475μs	525μs	1-12
1.00ms	950μs	1.05ms	1-13
5.00ms	4.75ms	5.25ms	1-14
10.0ms	9.5ms	10.5ms	1-15
50.0ms	47.5ms	52.5ms	1-16
99.9ms	94.9ms	104.9ms	1-17

† It is acceptable to program the value to less than 3.33ns so that this specification is met.

---

## Delay Test

This test consists of two parts:

1. Short Delay Test
2. Long Delay Test

---

**Note** Repeat the entire delay test procedure for the second channel, if installed.



---

The specifications and tests are for the 50% point of amplitude.

## Specifications

Range: 0ns to 99.9ms

Fixed Delay (Trigger Output to Main Output):

18ns

Maximum Delay:  $3.33\text{ns} \leq \text{Period} < 4.99\text{ns}$ : Max. Delay = (50% of Period) - 1.00ns

$5.00\text{ns} \leq \text{Period} < 19.9\text{ns}$ : Max. Delay = (70% of Period) - 2.00ns

$\text{Period} \geq 20.0\text{ns}$ : Max. Delay = (90% of Period) - 6.00ns

Accuracy: 5% of programmed value  $\pm 1.5\text{ns}$

rms Jitter: 10ns to 100ns range: 0.05% of prog. value +15ps

All other ranges: 0.025% of programmed value

+15ps

Repeatability: Factor 4 better than accuracy



## **Equipment**

- HP 54121T Digitizing Oscilloscope with Accessory
- Pulse Generator
- Counter
- Cable, 50Ω, BNC to BNC, coaxial, 2 each.

## Delay Test, Part 1: Short Delay Test

### Set-Up

#### 1. Set Pulse Generator:

PER = 500ns

WID = 100ns

HIL = 0.5V LOL = -0.5V

Fixed Transition Time

#### 2. Set the HP 8130A:

MODE	TRIG		OPT 020
	Slope positive		
TIMING	DEL	: 0ns	0ns
	WIDTH	: 100ns	10ns
	LEAD	: 1.00ns	1.00ns
	TRA	: 1.00ns	1.00ns
OUTPUT	HIGH	: 1.5V	1.5V
	LOW	: -1.5V	-1.5V
	ENABLE		DISABLE

3. Connect the Pulse Generator's Output via a 50Ω feedthrough to the HP 8130A's EXT INPUT.
4. Connect the HP 8130A's TRIG OUTPUT via a BNC(m) to SMA(f) adapter, a SMA(m-m) coaxial cable assembly, and APC 3.5mm 20dB Attenuator (f-m) to the Input 3 of the HP 54121A.
5. Connect the HP 8130A OUTPUT 1/2 via a same second accessory assembly to the Input 4 of the HP 54121A.

### C-8 Performance Tests

6. Connect the Pulse Generator's Trigger Output via a third accessory assembly to the TRIG input of the HP 54121A.

**Procedure**

1. Setup HP 54121T Oscilloscope:
  - a. press AUTOSCALE
  - b. set TIME/DIV = 20ns/div
  - c. select the Display menu and set the Screen function to Single set the Number of Averages to 64
  - d. select the  $\Delta V$  menu and turn the voltage markers On and assign marker 1 to channel 3 and marker 2 to channel 4
  - e. set Preset Levels = 50-50% and press Auto Level Set
  - f. select the  $\Delta t$  menu and turn the time markers On
  - g. set START ON EDGE = POS1 and STOP ON EDGE = POS1
  - h. Press Precise Edge Find
2. Press the Precise Edge Find key for each new Delay setting.
3. Check the HP 8130A delay at the following settings:

Delay	Acceptable Range		TR Entry
1.	0.00ns		†fixed Delay 2-1
2.	10.0ns	8.0ns	12.0ns 2-2
3.	20.0ns	17.5ns	22.5ns 2-3
4.	50.0ns	46.0ns	54.0ns 2-4
5.	80.0ns	74.5ns	85.5ns 2-5
6.	99.9ns	93.4ns	106.4ns 2-6

†Record the value of the fixed Delay, and subtract it from the other readings.

4. Step with the Vernier up keys from:

a. 0ps to 100ps in 10ps steps

b. 100ps to 1ns in 100ps steps

c. 1ns to 10ns in 1ns steps

Check the function/variation on scope.



## Delay Test, Part 2: Long Delay Test

### Set-Up

1. Set the HP 8130A:

MODE	AUTO	OPT 020
TIMING PERIOD	: 95 $\mu$ s	
DEL	: 100ns	0ns
WIDTH	: 100ns	10ns
LEAD	: 1.00ns	1.00ns
TRA	: 1.00ns	1.00ns
OUTPUT HIGH	: +1.5V	+1.5V
LOW	: -1.5V	-1.5V
ENABLE		DISABLE

2. Set the Counter:
  - a. FUNCTION = TI A to B
  - b. START = 50 $\Omega$ , POS (+) slope, DC, X1
  - c. STOP = 50 $\Omega$ , POS (+) slope, DC, X1
  - d. Gate Time = as necessary
  - e. INPUT MODE = SEP (SEPARATE)
  - f. START/STOP trigger levels = preset
3. Connect the HP 8130A TRIG OUTPUT to the Counter's START input.
4. Connect the HP 8130A OUTPUT 1/2 to the Counter's STOP input.

### Procedure

Check the HP 8130A delay at the following Period and Delay settings:

Period	Delay	Acceptable	Range	TR	Entry
†95μs	100ns	93.5ns	106.5ns	2-7	
†95μs	500ns	473.5ns	526.5ns	2-8	
†95μs	999ns	947.55ns	1.051μs	2-9	
99.9ms	100μs	95μs	105μs	2-10	
99.9ms	1ms	950μs	1.05ms	2-11	
99.9ms	80ms	76ms	84ms	2-12	

†Take the fixed delay into account.

---

## Double Pulse Test

This test consists of two parts:

1. Short Double Pulse Test
2. Long Double Pulse Test

---

### Note



Repeat the entire double pulse test procedure for the second channel, if installed.

---

The specifications and tests are for the 50% point of amplitude.

## Specifications

Range: 3.33ns to 99.9ms

### Maximum

Double Pulse: Period < 7.1ns: Max Double Pulse = n/a

7.2ns ≤ Period ≤ 9.99ns: Max Double Pulse = 50% of Period

Period ≥ 10.0ns: (90% of Period) - 4.00ns

Resolution: 3 digits (best case: 10ps)

Accuracy: 5% of programmed value ±250ps

rms Jitter: 10ns to 100ns range: 0.05% of prog. value

+15ps

All other ranges: 0.025% of programmed value

+15ps

Repeatability: Factor 4 better than accuracy

**Equipment**

- HP 54121T Digitizing Oscilloscope with Accessory
- Counter
- Cable, 50Ω, BNC to BNC, coaxial, 2 each.





## Double Pulse Test, Part 1: Short Double Pulse Test

### Set-Up

1. Set the HP 8130A:

MODE	AUTO	OPT 020
TIMING PERIOD	: 200ns	
DOUB	: 20ns	2ns
WIDTH	: 10ns	1.5ns
LEAD	: 1.00ns	1.00ns
TRA	: 1.00ns	1.00ns
OUTPUT HIGH	: +1.5V	+1.5V
LOW	: -1.5V	-1.5V
ENABLE		DISABLE

2. Connect the HP 8130A's TRIG OUTPUT via a BNC(m) to SMA(f) adapter, SMA(m-m) coaxial cable assembly, and an APC 3.5mm 20dB Attenuator (f-m) to the TRIG Input of the HP 54121A.
3. Connect the HP 8130A OUTPUT 1/2 via a same second accessory assembly to the Input 4 of the HP 54121A.

### Procedure

1. Setup HP 54121T Oscilloscope:
  - a. press AUTOSCALE
  - b. select the Display menu and set the Number of Averages to 64
  - c. select the  $\Delta V$  menu and turn the voltage markers On
  - d. set Preset Levels = 50-50% and press Auto Level Set
  - e. select the  $\Delta t$  menu and turn the time markers On

- f. set START ON EDGE = POS1 and STOP ON EDGE = POS2
2. Press the Precise Edge Find key for each new Double setting.
  3. Check the HP 8130A double pulse delay at the following settings:

Double	Acceptable Range		TR Entry
20.0ns	18.75ns	21.25ns	3-1
50.0ns	47.25ns	52.75ns	3-2
80.0ns	75.75ns	84.25ns	3-3
99.9ns	94.65ns	105.15ns	3-4

4. Change the HP 8130A Width to 1.5ns, and Double to 3.33ns.
5. Check the HP 8130A double pulse delay at the following settings:

Double	Acceptable Range		TR Entry
3.33ns	2.51ns	3.75ns	3-5
5.00ns	4.5ns	5.5ns	3-6
10.0ns	9.25ns	10.75ns	3-7

## Double Pulse Test, Part 2: Long Double Pulse Test

### Set-Up

1. Set the HP 8130A:

MODE	AUTO	OPT 020
TIMING PERIOD	: 95 $\mu$ s	
DOUB	: 200ns	2ns
WIDTH	: 100ns	1.5ns
LEAD	: 1.00ns	1.00ns
TRA	: 1.00ns	1.00ns
OUTPUT HIGH	: +1.5V	+1.5V
LOW	: -1.5V	-1.5V
ENABLE		DISABLE

2. Set the Counter:

FUNCTION = TI A to B

START = 50 $\Omega$ , POS (+) slope, DC, X1

STOP = 50 $\Omega$ , POS (+) slope, DC, X1

Gate Time = as necessary

INPUT MODE = COM

START/STOP trigger levels = Preset

3. Connect the HP 8130A OUTPUT 1/2 to the Counter's START input.

### Procedure

Check the HP 8130A double pulse delay at the following Period and Double settings:

<b>Period</b>	<b>Double</b>	<b>Acceptable Range</b>		<b>TR Entry</b>
95 $\mu$ s	200ns	189.75ns	210.25ns	3-8
95 $\mu$ s	1 $\mu$ s	950ns	1.05 $\mu$ s	3-9
95 $\mu$ s	10 $\mu$ s	9.5 $\mu$ s	10.5 $\mu$ s	3-10
99.9ms	100 $\mu$ s	95 $\mu$ s	105 $\mu$ s	3-11
99.9ms	1ms	950 $\mu$ s	1.05ms	3-12
99.9ms	10ms	9.5ms	10.5ms	3-13
99.9ms	80ms	76ms	84ms	3-14

---

## Width Test

This test consists of two parts.

1. Short Width Test
2. Long Width Test

---

**Note** Repeat the entire width test procedure for the second channel, if installed.



---

The specifications and tests are for the 50% point of amplitude.

## Specifications

Range: 1.5ns to 99.9ms

Maximum Width:  $3.33\text{ns} \leq \text{Period} \leq 4.99\text{ns}$ : Max Width = 50% of period)

$5.00 \leq \text{Period} \leq 19.9$ : Max Width = (70% of Period) - 1ns

$\text{Period} \geq 20.0\text{ns}$ : (90% of Period) - 5.00ns

Resolution: 3 digits (best case: 10ps)

Accuracy: 5% of programmed value  $\pm 250\text{ps}$

rms Jitter: 10ns to 100ns range: 0.05% of prog. value

+15ps

All other ranges: 0.025% of programmed value

+15ps

Repeatability: Factor 4 better than accuracy

**Equipment**

- HP 54121T Digitizing Oscilloscope with Accessory
- Counter
- Cable, 50Ω, BNC to BNC, coaxial, 2 each.



## Width Test, Part 1: Short Width Test

### Set-Up

1. Set the HP 8130A:

MODE	AUTO	OPT 020
TIMING PERIOD	: 200ns	
DEL	: 0ns	0ns
WIDTH	: 10ns	15ns
LEAD	: 1.00ns	1.00ns
TRA	: 1.00ns	1.00ns
OUTPUT HIGH	: +1.5V	+1.5V
LOW	: -1.5V	-1.5V
ENABLE		DISABLE

2. Connect the HP 8130A's TRIG OUTPUT via a BNC(m) to SMA(f) adapter, SMA(m-m) coaxial cable assembly, and APC 3.5mm 20dB Attenuator (f-m) to the TRIG Input of the HP 54121A.
3. Connect the HP 8130A OUTPUT 1/2 via a same second accessory, assembly to the Input 4 of the HP 54121A.

### Procedure

1. Setup HP 54121T Oscilloscope:
  - a. press AUTOSCALE
  - b. select the Display menu and set the Number of Averages to 64
  - c. select the  $\Delta V$  menu and turn the voltage markers On
  - d. set Preset Levels = 50-50% and press Auto Level Set
  - e. select the  $\Delta t$  menu and turn the time markers On

- f. set START ON EDGE = POS1 and STOP ON EDGE = NEG1
2. Change the scope timebase to 500ps/div. Change the HP 8130A Width to 1.5ns.
3. Press the Precise Edge Find key for each new Width setting.
4. Check the HP 8130A pulse width at the following settings:

Width	Acceptable Range	TR	Entry
1.5ns	1.175ns	1.825ns	4-1
2.00ns	1.65ns	2.35ns	4-2
5.00ns	4.5ns	5.5ns	4-3
10.0ns	9.25ns	10.75ns	4-4
20.0ns	18.75ns	21.25ns	4-5
50.0ns	47.25ns	52.75ns	4-6
80.0ns	75.75ns	84.25ns	4-7
99.9ns	94.65ns	105.15ns	4-8

5. Step with the Vernier up keys from:
  - a. 1.5ns to 1.6ns in 10ps steps
  - b. 1.6ns to 2ns in 100ps steps
  - c. 2ns to 10ns in 1ns steps
 Check the function/variation on scope.



## Width Test, Part 2: Long Width Tests

### Set-Up

1. Set the HP 8130A:

MODE	AUTO	OPT 020
TIMING PERIOD	: 95 $\mu$ s	
DEL	: 0ns	0ns
WIDTH	: 500ns	1.5ns
LEAD	: 1.00ns	1.00ns
TRA	: 1.00ns	1.00ns
OUTPUT HIGH	: +1.5V	+1.5V
LOW	: -1.5V	-1.5V
ENABLE		DISABLE

2. Set the Counter:

FUNCTION = TI A to B

START = 50 $\Omega$ , POS (+) slope, DC, X1

STOP = 50 $\Omega$ , NEG (-) slope, DC, X1

Gate Time = as necessary

INPUT MODE = COM

START/STOP trigger levels = Preset

3. Connect the HP 8130A OUTPUT 1/2 to the Counter's START input.

### Procedure

Check the HP 8130A pulse width at the following Period and Width settings:

Period	WIDTH	Acceptable Range		TR Entry
95μs	500ns	474.75ns	525.25ns	4-9
95μs	999ns	948.8ns	1.049μs	4-10
95μs	10μs	9.5μs	10.5μs	4-11
99.9ms	100μs	95μs	105μs	4-12
99.9ms	1ms	950μs	1.05ms	4-13
99.9ms	80ms	76ms	84 ms	4-14

---

## Jitter Test

This test consists of three parts:

1. Period Jitter
2. Delay Jitter
3. Width Jitter

---

**Note** Repeat the tests for the second channel, if installed.



---

## Specifications

rms Jitter: 10ns to 100ns range: 0.05% of programmed value

+15ps

All other ranges: 0.025% of programmed value

+15ps

## Equipment

HP 54121T Digitizing Oscilloscope with Accessory HP 54008A Delay Line

## Jitter Test, Part 1: Period Jitter Test

### Set-Up

1. Set the HP 8130A:

MODE	AUTO	OPT 020
TIMING PERIOD	: 50ns	
DEL	: 0ns	0ns
WIDTH	: 25ns	500ps
LEAD	: 1.00ns	1.00ns
TRA	: 1.00ns	1.00ns
OUTPUT HIGH	: +1.0V	+1.0V
LOW	: -0.0V	-0.0V
ENABLE		DISABLE

2. Connect an APC 3.5mm 20dB Attenuator (f-m) to the TRIG Input of the HP 54121A.
3. Connect one output, APC 3.5mm (f), of the Power Splitter HP 11667B via a SMA (m-m) Adapter to the 20dB Attenuator at the TRIG Input of the 54121A.
4. Connect the other output of the Power Splitter via a SMA(m-m) coaxial cable assembly to one of the SMA connectors on the HP 54008A.
5. Connect the free SMA connector on the HP 54008A Delay Line to input 3 of the HP 54121A
6. Connect the 8130A OUTPUT 1/2 via a BNC(m) to SMA(f) adapter, and a coaxial cable assembly SMA (m-m) to the Input of the Power Splitter.

### Procedure

1. Setup HP 54121T Oscilloscope:

### C-26 Performance Tests

- a. press AUTOSCALE
  - b. select the Display menu and set the Number of Averages to 128
  - c. select the Timebase menu and set the TIME/DIV to 200ps/div
  - d. center the first positive going edge of the signal (approx. Delay = 26.4ns)
  - e. select the Channel menu and set the Attenuation factor to 1 (Channel 3)
  - f. set the VOLT/DIV to 10mV/div
  - g. select the  $\Delta V$  menu and turn the V Markers On
  - h. set the Marker 1 Position to 240mV and the Marker 2 Position to 245mV
  - i. select the  $\Delta t$  menu and turn the T Markers On
  - j. set START ON EDGE = POS1 and STOP ON EDGE = POS1
  - k. press the Precise Edge Find key
2. RECORD the  $\Delta t$ ! It is the rise time of the ref. signal within a 1% amplitude window of the signal connected to Input 3. This value is needed later to calculate the correct jitter.
  3. Select the scopes Timebase menu and center the second positive going edge of the signal (actual Delay +50.xns = approx. Delay 66.xns)
  4. Press More and Histogram.
  5. Select the Window submenu and set:
    - Source is Channel 3
    - choose the time Histogram
    - press WINDOW MARKER 1 and set it to 240mV
    - press WINDOW MARKER 2 and set it to 245mV
  6. Select the Acquire submenu and set the Number of Samples to 1000. Press Start Acquiring.
  7. After the data for the time histogram is acquired (#Samples = 100%), select the Result submenu.

8. Press Mean and Sigma. Notice the value of Sigma!

9. The rms jitter has to be calculated as follows:

$$\frac{6\sigma - \Delta t_{ref\ signal}}{6}$$

10. Maximum rms jitter ( period = 50ns ) is 40ps      TR Entry 5-1

11. Set the HP 8130A: PER 500ns

12. Repeat steps 3 to 9.

---

**Note**      Time/Div 100ps/div Delay approx. 51x.xns



---

Maximum rms jitter ( period = 500ns ) is 140ps      TR Entry 5-2

## Jitter Test, Part 2: Width Jitter Test

### Set-Up

1. Same set-up as before.
2. Set the HP 8130A:

TIMING PERIOD :  $1\mu\text{s}$  |  
WIDTH :  $1.5\text{ns}$  |  $1.5\text{ns}$

### Procedure

1. Setup HP 54121T Oscilloscope:
  - a. press the More key
  - b. select the Display menu and set the #Averages = 256
  - c. select the Timebase menu and center the first negative going edge of the signal (Time/Div 20ps/div, approx. Delay = 28.xns)
  - d. select the  $\Delta V$  menu and set the Marker 1 Position to 260mV and the Marker 2 Position to 255mV
  - e. select the  $\Delta t$  menu and set START ON EDGE = NEG1 and STOP ON EDGE = NEG1
  - f. press the Precise Edge Find key
2. Notice the  $\Delta t$ ! It is the fall time of the signal within a 1% amplitude window of the signal connected to Input 3. This value is needed later to calculate the correct jitter.
3. Set the HP 8130A: WID 50ns
4. Select the scopes Timebase menu and center the first neg. going edge of the signal ( Time/Div 20ps/div, Delay approx. 77.xns).
5. Press More = Histogram.
6. Select the Window submenu and press WINDOW MARKER 1 and set it to 260mV press WINDOW MARKER 2 and set it to 255mV

7. Select the Acquire submenu and press Start Acquiring.
8. After the data for the time histogram is acquired (#Samples = 100%), select the Result submenu.
9. Press Mean and Sigma. Notice the value of Sigma!
10. The rms jitter has to be calculated as follows:
 
$$\frac{6\sigma - \Delta t_{full\ time}}{6}$$
11. Maximum rms jitter ( width = 50ns ) is 40ps      TR Entry 5-3
12. Set the HP 8130A: WID 500ns
13. Repeat steps 4 to 8.

---

**Note**              Time/Div 100ps/div, Delay 51x.xns



---

Maximum rms jitter ( width 500ns ) is 140ps.      TR Entry 5-4

14. DISABLE THE HP 8130A OUTPUTS !

### Jitter Test, Part 3: Delay Jitter Test

#### Set-Up

1. Set the HP 8130A:



MODE	AUTO	OPT 020
TIMING PERIOD	: 500ns	
DEL	: 250ns	0ps
WIDTH	: 50ns	500ps
LEAD	: 1.00ns	1.00ns
TRA	: 1.00ns	1.00ns
OUTPUT HIGH	: +5V	+5V
LOW	: 0.0V	0.0V
DISABLE		DISABLE

2. Connect the HP 8130A's TRIG OUTPUT via a BNC(m) to SMA(f) adapter, a SMA(m-m) coaxial cable assembly, and APC 3.5mm 20dB Attenuator (f-m) to the TRIG Input of the HP 54121A.
3. Connect the HP 8130A OUTPUT 1/2 via a similar second accessory assembly to Input 3 of the HP 54121A.
4. ENABLE the output.

**Procedure**

1. Setup HP 54121T Oscilloscope:
  - a. press AUTOSCALE
  - b. select the Display menu and set the #Averages = 128
  - c. select the Timebase menu and set the TIME/DIV = 50ps/div
  - d. center the first positive going edge of the signal (approx. Delay = 26x.xns)
  - e. select the Channel menu and set the attenuation factor to 10, set the VOLT/DIV = 10mV/div, Offset = 2.500V
2. Press More = Histogram.

3. Select the Window submenu and press WINDOW MARKER 1 and set it to 2.450V press WINDOW MARKER 2 and set it to 2.445V
4. Select the Acquire submenu and press Start Acquiring.
5. After the data for the time histogram is acquired (#Samples = 100%), select the Result submenu.
6. Press Mean and Sigma. Notice the value of Sigma!
7. The rms jitter has to be calculated as follows:

$$\frac{6\sigma - \Delta t_{ref\ signal}}{6}$$

8. Max. rms jitter ( delay = 250ns ) is 67.5ps      TR Entry 5-5

---

## High Level and Low Level Tests

---

**Note** Repeat the high level and low level tests for the second channel, if installed.



---

## Specifications

---

**Note** This specification applies to 50 $\Omega$  sources and 50 $\Omega$  loads.



High Level: -4.90V to 5.00V.

Low Level: -5.00V to 4.90V.

Resolution: 3 digits (best case: 10.0mV).

Level Accuracy: 1% of programmed value  $\pm 3\%$  of pulse amplitude,  $\pm 40\text{mV}$ .

Repeatability: Factor 4 better than accuracy

Settling time: 20ns + transition time at fastest.

## Equipment

1. Multimeter
2. 50 $\Omega$  feedthrough termination, 0.1%, 10 W
3. Adapter, BNC to dual banana plug
4. Cables, BNC to BNC, two each.
5. Pulse Generator with a 50 $\Omega$  feedthrough termination

## High Level Test

### Set-Up

1. Set the HP 8130A:

MODE	AUTO	OPT 020
TIMING PERIOD	: 99.9ms	
DEL	: 30 $\mu$ s	0ps
WIDTH	: 50ms	500ps
LEAD	: 1.00ns	1.00ns
TRA	: 1.00ns	1.00ns
OUTPUT HIGH	: +5V	+5V
LOW	: 0.0V	0.0V
ENABLE		DISABLE

2. Set the Multimeter (HP 3478).
  - a. SGL TRIG = Single Trigger
  - b. Blue/AUTO ZERO = Auto Zero off
  - c. BLUE/4 = 4 digits
3. Set the Pulse Generator:
  - a. Mode: Trigger
  - b. Trigger slope positive
  - c. Width: 500ns
  - d. HIL: 2.0V
4. Connect the HP 8130A OUTPUT 1/2 via a 50 $\Omega$  feedthrough (0.1%, 10 W) , BNC (m-m) cable, and a BNC to dual banana plug adapter to the Multimeters Input.

### C-34 Performance Tests

5. Connect the HP 8130A TRIG OUTPUT to the Pulse Generators External Input.
6. Connect the Pulse Generators Output via a 50 $\Omega$  feedthrough terminator to the Multimeters Trigger Input.

**Procedure**

Check the HP 8130A high level at the following HIGH settings with the low level set to 0.00 V.

<u>High Level</u>	<u>Acceptable Range</u>		<u>TR Entry</u>
5.0V	4.76V	5.24V	6-1
3.0V	2.84V	3.16V	6-2
1.0V	920mV	1.08V	6-3
0.5V	440mV	560mV	6-4
0.1V	56mV	144mV	6-5

The low level 0.0V may vary within  $\pm 3\%$  of pulse amplitude,  $\pm 40\text{mV}$ .

## Low Level Test

### Set-Up

Set the HP 8130A:

MODE	AUTO	OPT 020
TIMING PERIOD	: 99.9ms	
DEL	: 30ms	0ps
WIDTH	: 50ms	500ps
LEAD	: 1.00ns	1.00ns
TRA	: 1.00ns	1.00ns
OUTPUT HIGH	: 0.0V	0.0V
LOW	: -0.1V	-0.1V
ENABLE		DISABLE

### Procedure

Check the HP 8130A low level at the following LOW settings with the high level set to 0.00V.

Low Level	Acceptable Range	TR Entry
-0.1V	56mV 144mV	6-6
-0.5V	440mV 560mV	6-7
-1.0V	920mV 1.08V	6-8
-3.0V	2.84V 3.16V	6-9
-5.0V	4.76V 5.24V	6-10

The high level 0.0V may vary within  $\pm 3\%$  of pulse amplitude,  $\pm 40\text{mV}$ .

### C-36 Performance Tests

---

## Transition Time Test

---

### Note



Repeat the entire transition time test procedure for the second channel, if it is installed.

---

### Specifications

Range: 1ns to 100 $\mu$ s

Resolution: 3 digits (best case 10ps)

Accuracy:  $\pm 10\%$  of programmed value  $\pm 300$ ps

### Equipment

HP 54121T Digitizing Oscilloscope with Accessory

### Set-Up

1. Set the HP 8130A:

MODE	AUTO	OPT 020
TIMING	PERIOD : 1 $\mu$ s	
	DEL : 10 $\mu$ s	0ps
	DCYC : 50%	50%
OUTPUT	HIGH : +5V	+5V
	LOW : 0.0V	0.0V
	ENABLE	DISABLE

2. Connect the HP 8130A's TRIG OUTPUT via a BNC(m) - SMA(f) adapter, Cable assembly-coaxial SMA(m-m), and APC 3.5mm 20db Attenuator (f-m) to the TRIG Input of the HP 54121A
3. Connect the HP 8130A OUTPUT 1/2 via a same second accessory assembly to the Input 4 of the HP 54121A.

### Procedure

1. Setup HP 54121T Oscilloscope:
  - a. press AUTOSCALE
  - b. center one pulse horizontal and vertical on screen (for example, TIME/DIV =  $50\mu\text{s}/\text{div}$ , DELAY =  $375\mu\text{s}$ , VOLT/DIV =  $800\text{mV}/\text{div}$ , Offset = 2.5V).
  - c. select the Display menu and set the Number of Averages to 64
  - d. select the Channel menu and set the Attenuation factor to 10
  - e. select the  $\Delta V$  menu and turn the voltage markers On
  - f. set Preset Levels = 10-90% and press Auto Level Set
  - g. select the Timebase menu and set TIME/DIV =  $2\mu\text{s}$ , DELAY = 16ns
  - h. select the  $\Delta t$  menu and turn the time markers On
  - i. set START ON EDGE = POS1 and STOP ON EDGE = POS1
2. Set HP 8130A: Period: 500ns
3. After the averaging, while the Oscilloscope is in the  $\Delta t$  menu, press the Precise Edge Find Key.
4. Check the HP 8130A rise times at the following leading edge settings



'Scope Time/Div	Period	Leading Edge	Trailing Edge	Acceptable Range		TR Entry
2ns	1 $\mu$ s	1ns†	1ns		1.31ns	7-1
5ns		10ns	5ns	8.7ns	11.3ns	7-2
10ns		50ns	50ns	44.7ns	55.3ns	7-3
20ns	5 $\mu$ s	100ns	500ns	90ns	110ns	7-4
100ns		500ns		400ns	550ns	7-5
200ns		1 $\mu$ s		900ns	1.10 $\mu$ s	7-6
500ns	50 $\mu$ s	2 $\mu$ s	5 $\mu$ s	1.80 $\mu$ s	2.20 $\mu$ s	7-7
1 $\mu$ s		5 $\mu$ s		4.50 $\mu$ s	5.5 $\mu$ s	7-8
2 $\mu$ s	500 $\mu$ s	10 $\mu$ s		9 $\mu$ s	11 $\mu$ s	7-9
10 $\mu$ s		50 $\mu$ s	50 $\mu$ s	45 $\mu$ s	55 $\mu$ s	7-10
20 $\mu$ s		100 $\mu$ s		90 $\mu$ s	110 $\mu$ s	7-11

† Underprogramming to 670ps is allowed to meet this specification.

5. Set the HP 8130A: Leading: 1ns, Trailing: 1ns
6. Select the 'scopes Timebase menu and set DELAY = 268ns  
Select the 'scopes  $\Delta t$  menu and set START ON EDGE = NEG1 and STOP ON EDGE = NEG1.
7. While the oscilloscope is in the  $\Delta t$  menu press the Precise Edge Find Key.
8. Check the HP 8130A output signal fall times at the following trailing edge settings

Scope Time/Div	Period	Trailing Edge	Leading Edge	Acceptable Range		TR Entry
2ns	1 $\mu$ s	1ns†	1ns	1.31ns	7-12	
5ns		10ns	5ns	8.7ns	11.3ns	7-13
10ns		50ns	50ns	44.7ns	55.3ns	7-14
20ns	5 $\mu$ s	100ns	500ns	90ns	110ns	7-15
100ns		500ns		400ns	550ns	7-16
200ns		1 $\mu$ s		900ns	1.10 $\mu$ s	7-17
500ns	50 $\mu$ s	2 $\mu$ s	5 $\mu$ s	1.80 $\mu$ s	2.20 $\mu$ s	7-18
1 $\mu$ s		5 $\mu$ s		4.50 $\mu$ s	5.5 $\mu$ s	7-19
2 $\mu$ s	500 $\mu$ s	10 $\mu$ s		9 $\mu$ s	11 $\mu$ s	7-20
10 $\mu$ s		50 $\mu$ s	50 $\mu$ s	45 $\mu$ s	55 $\mu$ s	7-21
20 $\mu$ s		100 $\mu$ s		90 $\mu$ s	110 $\mu$ s	7-22

† Underprogramming to 670ps is allowed to meet this specification.

---

## Pulse Aberration Test

---

**Note** Repeat this test for the second channel, if installed.



---

### Specifications

Overshoot and Ringing:  $\leq 10\%$  of the pulse amplitude  $\pm 20\text{mV}$ .

### Equipment

HP 54121T Digitizing Oscilloscope with Accessory

### Set-Up

1. Set the HP 8130A:

MODE	AUTO	OPT 020
TIMING PERIOD	: 500 $\mu\text{s}$	
DEL	: 5ns	0ps
DCYC	: 50%	50%
OUTPUT HIGH	: +5V	+5V
LOW	: 0.0V	0.0V
ENABLE		DISABLE

2. Connect the HP 8130A's TRIG OUTPUT via a BNC(f) - SMA(m) adapter and Cable assembly-coaxial SMA (m-m), and APC 3.5mm 20dB Attenuator (f-m) to the TRIG Input of the HP 54121A.
3. Connect the HP 8130A OUTPUT 1/2 via a same second accessory assembly to the Input 4 of the HP 54121A.

## Procedure

1. Setup HP 54121T Oscilloscope:
  - a. press AUTOSCALE
  - b. center one pulse horizontal and vertical on screen (e.g. TIME/DIV =  $50\mu\text{s}/\text{div}$ , DELAY =  $377\mu\text{s}$ , VOLT/DIV =  $800\text{mV}/\text{div}$ )
  - c. select the Display menu and set the Number of Averages to 64
  - d. select the Channel menu and set the Attenuation factor to 10
  - e. select the  $\Delta\text{V}$  menu and turn the voltage markers On
  - f. set the VARIABLE LEVELS = 90-110% and press Auto Level Set
  - g. select the Channel menu and center vertical the pulse top (Offset = 5V)
  - h. set the VOLTS/DIV to  $500\text{mV}/\text{div}$
  - i. select the Timebase menu and set TIME/DIV =  $500\text{ ps}$ , DELAY =  $21.5\text{ns}$
2. Set HP 8130A: Period:  $500\text{ns}$
3. Check the Overshoot and Ringing for  $\leq 10\% \pm 20\text{mV}$  TR Entry 8-1

---

### Note

Take the scopes trace flatness error (GaAs input circuit) into account.



- 
4. Repeat steps 1 to 3.  
Set HP 8130A; HIGH =  $500\text{mV}$  TR Entry 8-2

---

## Performance Test Record

MODEL: HP 8130A

TESTED BY: \_\_\_\_\_

SERIAL NUMBER: \_\_\_\_\_ DATE: \_\_\_\_\_

CUSTOMER: \_\_\_\_\_ CSO#: \_\_\_\_\_

COMMENTS:

Test	Limit Minimum	Actual (TR Entry)	Limit Maximum	Pass	Fail
<b>Period:</b>					
3.33ns	3.06ns	(1-1)_____	3.56ns	___	___
5.00ns	4.65ns	(1-2)_____	5.35ns	___	___
10.0ns	9.4ns	(1-3)_____	10.6ns	___	___
50.0ns	47.4ns	(1-4)_____	52.6ns	___	___
100ns	94.9ns	(1-5)_____	105.1ns	___	___
500ns	474.9ns	(1-6)_____	525.1ns	___	___
1.00μs	949.9ns	(1-7)_____	1.05μs	___	___
5.00μs	4.75μs	(1-8)_____	5.25μs	___	___
10.0μs	9.5μs	(1-9)_____	10.5μs	___	___
50.0μs	47.5μs	(1-10)_____	52.5μs	___	___
100μs	95μs	(1-11)_____	105μs	___	___
500μs	475ms	(1-12)_____	525μs	___	___
1.00ms	950ms	(1-13)_____	1.05ms	___	___
5.00ms	4.75ms	(1-14)_____	5.25ms	___	___
10.0ms	9.5ms	(1-15)_____	10.5ms	___	___
50ms	47.5ms	(1-16)_____	52.5ms	___	___
99.9ms	94.9ms	(1-17)_____	104.9ms	___	___



**C-44 Performance Tests**

Test	Limit Minimum	Actual (TR Entry)	Limit Maximum	Pass	Fail
<b>Short Delay:</b>					
0.00ns		(2-1)_____		---	---
10.0ns	8.0ns	(2-2)_____	12.0ns	---	---
20.0ns	17.5ns	(2-3)_____	22.5ns	---	---
50.0ns	46.0ns	(2-4)_____	54.0ns	---	---
80.0ns	74.5ns	(2-5)_____	85.5ns	---	---
99.9ns	93.4ns	(2-6)_____	106.4ns	---	---
<b>Long Delay:</b>					
100ns	93.5ns	(2-7)_____	106.5ns	---	---
500ns	473.5ns	(2-8)_____	526.5ns	---	---
999ns	947.55ns	(2-9)_____	1.051 $\mu$ s	---	---
100 $\mu$ s	95 $\mu$ s	(2-10)_____	105 $\mu$ s	---	---
1ms	950ms	(2-11)_____	1.05ms	---	---
80ms	76ms	(2-12)_____	84ms	---	---

Test	Limit Minimum	Actual (TR Entry)	Limit Maximum	Pass	Fail
<b>Short Double Pulse:</b>					
20.0ns	18.75ns	(3-1)_____	21.25ns	___	___
50.0ns	47.25ns	(3-2)_____	52.75ns	___	___
80.0ns	75.75ns	(3-3)_____	84.25ns	___	___
99.9ns	94.65ns	(3-4)_____	105.15ns	___	___
3.33ns	2.91ns	(3-5)_____	3.75ns	___	___
5.00ns	4.5ns	(3-6)_____	5.5ns	___	___
10.0ns	9.25ns	(3-7)_____	10.75ns	___	___

<b>Long Double Pulse:</b>					
200ns	189.75ns	(3-8)_____	210.25ns	___	___
1 $\mu$ s	950ns	(3-9)_____	1.05 $\mu$ s	___	___
10 $\mu$ s	9.5 $\mu$ s	(3-10)_____	10.5 $\mu$ s	___	___
100 $\mu$ s	95 $\mu$ s	(3-11)_____	105 $\mu$ s	___	___
1ms	950 $\mu$ s	(3-12)_____	1.05ms	___	___
10ms	9.5ms	(3-13)_____	10.5ms	___	___
80ms	76ms	(3-14)_____	84ms	___	___



Test	Limit Minimum	Actual (TR Entry)	Limit Maximum	Pass	Fail
------	------------------	----------------------	------------------	------	------

**Short Width:**

1.5ns	1.175ns	(4-1)_____	1.825ns	___	___
2.00ns	1.65ns	(4-2)_____	2.35ns	___	___
5.00ns	4.5ns	(4-3)_____	5.5ns	___	___
10.0ns	9.25ns	(4-4)_____	10.75ns	___	___
20.0ns	18.75ns	(4-5)_____	21.25ns	___	___
50.0ns	47.25ns	(4-6)_____	52.75ns	___	___
80.0ns	75.75ns	(4-7)_____	84.25ns	___	___
99.9ns	94.65ns	(4-8)_____	105.15ns	___	___

**Long Width:**

500ns	474.75ns	(4-9)_____	525.25ns	___	___
999ns	948.8ns	(4-10)_____	1.049 $\mu$ s	___	___
10 $\mu$ s	9.5 $\mu$ s	(4-11)_____	10.5 $\mu$ s	___	___
100 $\mu$ s	95 $\mu$ s	(4-12)_____	105 $\mu$ s	___	___
1ms	950 $\mu$ s	(4-13)_____	1.05ms	___	___
80ms	76ms	(4-14)_____	84ms	___	___

Test	Limit Minimum	Actual (TR Entry)	Limit Maximum	Pass	Fail
<b>Period Jitter:</b>					
≤ 40ps		(5-1)_____		___	___
≤ 140ps		(5-2)_____		___	___
<b>Width Jitter:</b>					
≤ 40ps		(5-3)_____		___	___
≤ 140ps		(5-4)_____		___	___
<b>Delay Jitter:</b>					
≤ 67.5ps		(5-5)_____		___	___
<b>High Level:</b>					
5.0V	4.76V	(6-1)_____	5.24V	___	___
3.0V	2.84V	(6-2)_____	3.16V	___	___
1.0V	920mV	(6-3)_____	1.08V	___	___
0.5V	440mV	(6-4)_____	560mV	___	___
0.1V	56mV	(6-5)_____	144mV	___	___

Test	Limit Minimum	Actual (TB Entry)	Limit Maximum	Pass	Fail
------	---------------	-------------------	---------------	------	------

**Low Level:**

-0.1V	-56mV	(6-6)_____	-144mV	___	___
-0.5V	-440mV	(6-7)_____	-560mV	___	___
-1.0V	-920mV	(6-8)_____	-1.08V	___	___
-3.0V	-2.84V	(6-9)_____	-3.16V	___	___
-5.0V	-4.76V	(6-10)_____	-5.24V	___	___

**Leading Edge:**

1ns		7-1 _____	1.31ns	___	___
10ns	8.7ns	7-2 _____	11.3ns	___	___
50ns	44.7ns	7-3 _____	55.3ns	___	___
100ns	90ns	7-4 _____	110ns	___	___
500ns	400ns	7-5 _____	550ns	___	___
1 $\mu$ s	900ns	7-6 _____	1.10 $\mu$ s	___	___
2 $\mu$ s	1.80 $\mu$ s	7-7 _____	2.20 $\mu$ s	___	___
5 $\mu$ s	4.50 $\mu$ s	7-8 _____	5.5 $\mu$ s	___	___
10 $\mu$ s	9 $\mu$ s	7-9 _____	11 $\mu$ s	___	___
50 $\mu$ s	45 $\mu$ s	7-10 _____	55 $\mu$ s	___	___
100 $\mu$ s	90 $\mu$ s	7-11 _____	110 $\mu$ s	___	___

Test	Limit Minimum	Actual (TR Entry)	Limit Maximum	Pass	Fail
<b>Trailing Edge:</b>					
1ns		7-12 _____	1.31ns	___	___
10ns	8.7ns	7-13 _____	11.3ns	___	___
50ns	44.7ns	7-14 _____	55.3ns	___	___
100ns	90ns	7-15 _____	110ns	___	___
500ns	400ns	7-16 _____	550ns	___	___
1 $\mu$ s	900ns	7-17 _____	1.10 $\mu$ s	___	___
2 $\mu$ s	1.80 $\mu$ s	7-18 _____	2.20 $\mu$ s	___	___
5 $\mu$ s	4.50 $\mu$ s	7-19 _____	5.5 $\mu$ s	___	___
10 $\mu$ s	9 $\mu$ s	7-20 _____	11 $\mu$ s	___	___
50 $\mu$ s	45 $\mu$ s	7-21 _____	55 $\mu$ s	___	___
100 $\mu$ s	90 $\mu$ s	7-22 _____	110 $\mu$ s	___	___

**Pulse Aberration**

$\leq 10\% \pm 20\text{mV}$	(8-1)_____	___	___
$\leq 10\% \pm 20\text{mV}$	(8-2)_____	___	___

---

## Recommended Test Equipment

Other equipment can be used provided it meets the specifications of this equipment.

**Table C-1.**

Type (Quantity)	Model	Specifications
50 $\Omega$ feedthrough (1) termination	HP 10100C	50 $\Omega$ , 2W, 1%.
50 $\Omega$ feedthrough (1) termination	See Figure C-1.	50 $\Omega$ , 10 W, 0.1%.
Adapter, (1) BNC to Banana	HP 1251-2277	BNC(f) to dual banana plug, 50 $\Omega$
Cable Assembly (5)	HP 8120-1839	50 $\Omega$ , 24 inches, coax, 2 BNC (m).

**Table C-1. (continued)**

Type (Quantity)	Model	Specifications
Counter (1)	HP 5335A/	50 uHz to 50MHz;
	HP 5370B	8 digit display; INPUT: 50Ω/1MΩ, X1/X10, AC/DC, separate/common; variable trigger level; TI/PERIOD/FREQUENCY.
Isolation Transformer (1)		Suitable for use with the variac.
Multimeter (1)	HP 3478A/	4 1/2 digit
	HP 3456A	display; VDC: 30mV to 300V; 30 to 35 readings/second; external trigger; input resistance: >10 MΩ



**Table C-1. (continued)**

<b>Type (Quantity)</b>	<b>Model</b>	<b>Specifications</b>
Oscilloscope (1) (Sampling)	HP 54121T	20GHz
Sampling Scope Accessories		
Attenuator (3)	33340C	APC 3.5mm (f-m), 20 dB
Adapter (2)	1250-1200	SMA (m) to BNC (f)
Cable (3)	8120-4948	SMA (m-m) coaxial
Adapter (1)	1250-1159	SMA (m-m)
Adapter (2)	1250-1700	SMA (f) to BNC (m)
Power Splitter (1)	11667B	APC 3.5mm
Variac (1) (Variable AC Power Supply)		$\geq 5$ A, 0-300VAC

**Table C-1. (continued)**

Type (Quantity)	Model	Specifications
Power Supply (1)	HP 6205A/ HP 6237A	0-60VDC, 0-3 A.
Pulse Generator (1)	HP 8112A/ HP 8161A	1 Hz to 50MHz; variable delay; variable width; variable pulse; external trigger; output amplitude: > 5V.
Signature Analyzer (1)	HP 5005A/ HP 5006A	TTL, 4 digit display, HEX, 25 M Hz clock, setup time = 20ns, probe = 50Ω to ground.
TEE (1)	HP 1250-0781	50Ω, BNC(m)(f)(f).



## Feedthrough Termination

This feedthrough must be used only where specified for DC voltage measurements.

The following figure provides a schematic and a parts list except for the case. The case must provide shielding and maintain grounding integrity.

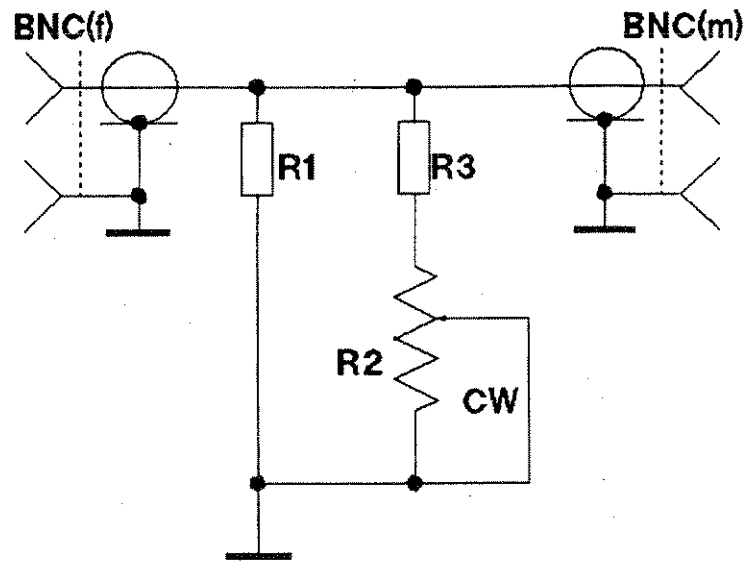

Figure C-1. 50, 0.1%, 10W Feedthrough Termination

R1 = 53.6 $\Omega$ , 1%, 10 W; HP Part Number: 0699-0146.

R2 = 200 $\Omega$ , 10%, 0.5 W, Variable trimmer; HP Part Number: 2100-3350.

R3 = 681 $\Omega$ , 1%, 0.5 W; HP Part Number: 0757-0816.

BNC (M): HP Part Number: 1250-0045.

BNC (F): HP Part Number: 1250-0083.

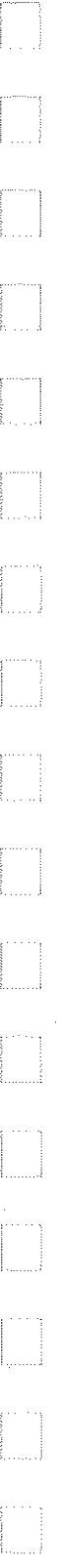

# D

## Options and Accessories

---

### Options

- 001 Rear panel connectors
- 020 Second Channel
- 908 Rack Mounting Flange Kit  
(P/N 5062-3977)
- 916 One Operating and Programming Manual  
(P/N 08130-90011)
- W30 Two additional years of Return-to-HP service



## **Command Cross-References**

---

### **Introduction**

The tables in this appendix cross reference comparable but not identical commands. For example, the HP 8112A interrogate command `IHIL` returns a message that contains the mnemonic, value, and units. The comparable HP 8130A command, `:PULSe:LEVel:HIGH?`, returns only the value in decimal format. Therefore, it is important to consult Chapters 5, 6, and 7 for additional HP 8130A command information.

Chapter 5 describes the instrument functions as they are used in the local operating mode. Each cross reference table contains a column labeled `LOCAL` which identifies the alpha listing of that function in Chapter 5, for example, `LOW`.

Chapter 6 contains an alpha listing of the common commands, for example, `*RST`.

Chapter 7 contains

- An alpha listing of the device commands listed by command header, for example, `:PULSe:TIMing:DutyCYCle`
- Syntax diagrams

# HP8112A and HP8130A

Table E-1. HP 8112A and HP 8130A

HP 8112A	HP 8130A	LOCAL
BUR 1234#	:PULSe:COUNt 1234	COUNT
CO	:OUTPut:PULSe:POLarity NORMal	COMP
C1	:OUTPut:PULSe:POLarity COMPlément	COMP
CST	*LRN?	---
CT0	not available	---
CT1	not available	---
CT2	not available	---
CT3	not available	---
CT4	not available	---
DO	:OUTPut:PULSe:STATe OFF	DISABLE
D1	:OUTPut:PULSe:STATe ON	DISABLE
DBL 200 $\mu$ s	:PULSe:TIMing:DOUBle 200 $\mu$ s	DOUB
DEL 75.Ons	:PULSe:TIMing:DELay 75.Ons	DEL
DTY 10%	:PULSe:TIMing:DutyCYCle 10%	DCYC
EST	*TST?	---

Table E-1. HP 8112A and HP 8130A (continued)

HP 8112A	HP 8130A	LOCAL
HIL 2.00V	:PULSe:LEVel:HIGH 2.00V	HIGH
IBUR	:PULSe:TIMing:BURSt?	BURST
IDBL	:PULSe:TIMing:DOUBle?	DOUB
IDEL	:PULSe:TIMing:DELay?	DEL
IDTY	:PULSe:TIMing:DutyCYClE?	DCYC
IERR	:SYSTem:DERRor?	—
IHL	:PULSe:LEVel:HIGH?	HIGH
ILEE	:PULSe:EDGE:LEADing?	LEAD
ILOL	:PULSe:LEVel:LOW?	LOW
IPER	:PULSe:TIMing:PERiod?	PERIOD
IRLCn	not available	—
ITRE	PULSe:EDGE:TRAILing?	TRA
IWID	:PULSe:TIMing:WIDTh?	WIDTH
LO	:PULSe:LEVel:LIMit OFF	LIMIT
L1	:PULSe:LEVel:LIMit ON	LIMIT
LD	:SYSTem:KEY 3	—
LEE 20.0ns	:PULSe:EDGE:LEADing 20.0ns	LEAD
LOL 1.00V	:PULSe:LEVel:LOW 1.00V	LOW
LU	:SYSTem:KEY 4	—

Table E-1. HP 8112A and HP 8130A (continued)

HP 8112A	HP 8130A	LOCAL
M1	:INPut:TRIGger:MODE AUTO	AUTO
M2	:INPut:TRIGger:MODE TRIGger	TRIG
M3	:INPut:TRIGger:MODE GATE	GATE
M4	:INPut:TRIGger:MODE ExternalWIDTH	E. WIDTH
M5	:INPut:TRIGger:MODE BURSt	BURST
MD	:SYSTem:KEY 7	---
MU	:SYSTem:KEY 8	---
PER 1.00ms	:PULSe:TIMing:PERiod 1.00ms	PERIOD
RCL 1	*RCL 1	RCL
RD	:SYSTem:KEY 1	---
RU	:SYSTem:KEY 2	---
SD	:SYSTem:KEY 5	---
SRO	not available	---
SR1	not available	---
SMO	not available	---
SM1	:SYSTem:KEY 41 (See Chapter 5, SET.)	SET
STO 1	*SAV 1	SAVE
SU	:SYSTem:KEY 6	---

E-4 Command Cross-References



Table E-1. HP 8112A and HP 8130A (continued)

HP 8112A	HP 8130A	LOCAL
T0	not available	—
T1	:INPut:TRIGger:SLOPe POS	SLOPE
T2	:INPut:TRIGger:SLOPe NEG	SLOPE
T3	not available	—
TRE 20.0ns	:PULSe:EDGE:TRAILing 20.0ns	TRA
W1	not available	—
W2	not available	—
W3	not available	—
WID 100 $\mu$ s	:PULSe:TIMing:WIDTh 100 $\mu$ s	WIDTH

**Examples**

HP 8112A: OUTPUT 712;"M2T1"

HP 8130A: OUTPUT 711;":INP:TRIG:MODE TRIG;SLOP POS"

## HP 8160A, HP8161A and HP8130A

Table E-2. HP 8160A/61A and HP 8130A

HP 8160A/61A	HP 8130A	LOCAL
A1 (60A only)	not available	---
A5 (60A only)	not available	---
AA	not available	---
AC	:OUTPut1:PULSe:POLarity COMPLEMENT	COMP
AD (61 only)	:OUTPut1:PULSe:STATe OFF	DISABLE
AE (61 only)	:OUTPut1:PULSe:STATe ON	DISABLE
AN	:OUTPut1:PULSe:POLarity NORMAL	COMP
AS	not available	---
B1 (60A only)	not available	---
B5 (60A only)	not available	---
BC	:OUTPut2:PULSe:POLarity COMPLEMENT	COMP
BD (61A only)	:OUTPut2:PULSe:STATe OFF	DISABLE
BE (61A only)	:OUTPut2:PULSe:STATe ON	DISABLE
BN	:OUTPut2:PULSe:POLarity NORMAL	COMP
BUR 1234BT	:PULSe:COUNT 1234	COUNT
DBL 200 $\mu$ s	:PULSe:TIMing:DOUBle 200 $\mu$ s	DOUB
DEL 75.0ns	:PULSe:TIMing:DELay 75.0ns	DEL
DI	not available	---
	Outputs are independently disabled:	
	:OUTPut1:PULSe:STATe OFF	DISABLE
	:OUTPut2:PULSe:STATe OFF	DISABLE

### E-6 Command Cross-References

Table E-2. HP 8160A/61A and HP 8130A (continued)

HP 8160A/61A	HP 8130A	LOCAL
E1	:INPut:TRIGger:SLOPe POS	SLOPE
E2	:INPut:TRIGger:SLOPe NEG	SLOPE
EC (61A only)	not available	—
EN	not available	—
	Outputs are independently enabled:	
	:OUTPut1:PULSe:STATe ON	DISABLE
	:OUTPut2:PULSe:STATe ON	DISABLE
HIL 2.00V (60A-50 ohm only)	:PULSe:LEVel:HIGH 2.00V	HIGH
I1	:INPut:TRIGger:MODE AUTO	AUTO
I2	:INPut:TRIGger:MODE TRIGger	TRIG
I3	:INPut:TRIGger:MODE GATE	GATE
I4	:INPut:TRIGger:MODE BURSt	BURST
LEE 20.0ns	:PULSe:EDGE:LEADing 20.0ns	LEAD
LOL 1.00V (60A-50 ohm only)	:PULSe:LEVel:LOW 1.00V	LOW

Table E-2. HP 8160A/61A and HP 8130A (continued)

HP 8160A/61A	HP 8130A	LOCAL
PER 1.00ms	:PULSe:TIMing:PERiod 1.00ms	PERIOD
RCL 1	*RCL 1	RCL
SETn	not available	—
SET:	*LRN?	—
STO 1	*SAV 1	SAVE
TRE 20.0ns	:PULSe:EDGE:TRAILing 20.0ns	TRA
TT (61A only)	not available	—
WID 100 $\mu$ s	:PULSe:TIMing:WIDTh 100 $\mu$ s	WIDTH

**Examples**

HP 8160A: OUTPUT 717;"I2E1"

HP 8130A: OUTPUT 711;":INP:TRIG:MODE TRIG;SLOP POS"

## Register Bit Assignment

---

**Table F-1.**

Bit	Weight	Significance	Interface Assignment
[BIT 7]	128	Most (MSB)	DIO8
[BIT 6]	64		DIO7
[BIT 5]	32		DIO6
[BIT 4]	16		DIO5
[BIT 3]	8		DIO4
[BIT 2]	4		DIO3
[BIT 1]	2		DIO2
[BIT 0]	1	Least (LSB)	DIO1

---

**Note**

Unused register bits have a weight of zero or are ignored.





# G

## **Backdating**

---

### **Introduction**

This appendix contains backdating information, which adapts this manual to instruments with serial numbers other than that shown on the title page.

Changes are listed in the serial number order that they occurred in the manufacture of the instrument.

At the time of print there are no backdating changes.





## Errors

---

### Power-On Self-Test Errors

The instrument tests the microprocessor, timing, and output boards. Error conditions are reported at the display immediately after performing the tests.

**Table H-1. Power-On Self-Test Errors**

<u>Error Code</u>	<u>Processor Board Error Message</u>
F100	Static RAM (number 2) error
F101	Static RAM (number 1) error
F102	EPROM (number 2) error
F103	EPROM (number 1) error
F104	Timer cycle error
F105	Keyboard controller error
F106	Device bus error
F500	Configuration error
	An incorrect combination of timing and output boards has been installed in the instrument.

<u>Error Code</u>	<u>Timing Board Error Message</u>
E200	The adjust values on the EEPROM have been destroyed. Correct parametric timing is not possible.



Channel 1 Error Code	Channel 2 Error Code	Output Board Error Message
E300	E400	The high-level of the normal output (differential signal) of the hybrid board has failed (fast slope input).
E301	E401	The low-level of the inverted output (differential signal) of the hybrid board has failed (fast slope input).
E302	E402	The high-level of the inverted output (differential signal) of the hybrid board has failed (fast slope input).
E303	E403	The low-level of the normal output (differential signal) of the hybrid board has failed (fast slope input).
E304	E404	The fast slope normal output of the SMD board has failed.
E305	E405	The fast slope inverted output of the SMD board has failed.
E306	E406	The high-level of the SMD board input signal has failed.
E307	E407	The low-level of the SMD board input signal has failed.
E308	E408	The low-level of the slow slope output from the SMD board has failed.
E309	E409	The high-level of the slow slope output from the SMD board has failed.

Channel 1 Error Code	Channel 2 Error Code	Output Board Error Message
E310	E410	The high-level of the normal output (differential signal) of the hybrid board has failed (slow slope input).
E311	E411	The low-level of the inverted output (differential signal) of the hybrid board has failed (slow slope input).
E312	E412	The high-level of the inverted output (differential signal) of the hybrid board has failed (slow slope input).
E313	E413	The low-level of the normal output (differential signal) of the hybrid board has failed (slow slope input).
E350	E450	The adjust value on the EEPROM have been destroyed. Correct slopes and levels are not possible.



<b>Error Code</b>	<b>Configuration Error Message</b>
E500	Dual Channel Instrument Each output board contains a trigger amplifier. The trigger amplifier is required in channel 1 and is not needed in channel 2.
E501	Dual Channel Instrument Neither output board contains trigger amplifier capability.
E502	Single Channel Instrument The output board does not contain trigger amplifier capability.
E504	The Instrument Contains a dual channel timing board but only one output board.

---

### **\*TST? Errors**

The self-test query causes the instrument to test the timing and output board tests.



**\*TST? Errors**

<b>Channel 1</b>	<b>Channel 2</b>	<b>Output Board Error Message</b>
<b>Error Code</b>	<b>Error Code</b>	
300	400	The high-level of the normal output (differential signal) of the hybrid board has failed (fast slope input).
301	401	The low-level of the inverted output (differential signal) of the hybrid board has failed (fast slope input).
302	402	The high-level of the inverted output (differential signal) of the hybrid board has failed (fast slope input).
303	403	The low-level of the normal output (differential signal) of the hybrid board has failed (fast slope input).
304	404	The fast slope normal output of the SMD board has failed.
305	405	The fast slope inverted output of the SMD board has failed.
306	406	The high-level of the SMD board input signal has failed.
307	407	The low-level of the SMD board input signal has failed.
308	408	The low-level of the slow slope output from the SMD board has failed.
309	409	The high-level of the slow slope output from the SMD board has failed.

**\*TST? Errors (continued)**

<b>Channel 1 Error Code</b>	<b>Channel 2 Error Code</b>	<b>Output Board Error Message</b>
310	410	The high-level of the normal output (differential signal) of the hybrid board has failed (slow slope input).
311	411	The low-level of the inverted output (differential signal) of the hybrid board has failed (slow slope input).
312	412	The high-level of the inverted output (differential signal) of the hybrid board has failed (slow slope input).
313	413	The low-level of the normal output (differential signal) of the hybrid board has failed (slow slope input).

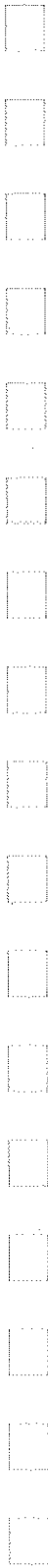



---

**:SYST:ERR?**

Command, execution, device dependent, and query error events are reported in response to the :ERR? query.

**Table H-2. :SYSTem:ERRor? Error Messages**

<b>Error Code</b>	<b>Command Error Messages</b>
	The occurrence of command errors also sets bit five (CME) of the standard event status register (ESR).
0	<No error>
-100	<Command Error>
	The command is invalid.
	1. The required command is incorrectly transmitted.
	2. The command is not allowed in the command path transmitted.
	<mnemonic> = the command mnemonic.
	<b>ERROR FREE</b>
-120	<Numeric Argument Error>
	The numeric argument is invalid.
-130	<Non-Numeric Argument Error>
	The non-numeric argument is invalid.

**Error Code                      Execution Error Message**

---

The occurrence of execution errors also sets  
bit four (EXE) of the standard event status register (ESR).

-200 <Generic Execution Error>

A :SYST:SET binary transfer has failed.

A remotely programmed level conflict occurred.

-212 <Argument Out of Range>

The received value is out of its allowed range.

See the syntax diagrams for the ranges.



<b>Error Code</b>	<b>Device Error Message</b>
-------------------	-----------------------------

The occurrence of device dependent errors also sets bit three (DDE) of the standard event status register (ESR).

**-312 <RAM Data Loss>**

RAM memory failure, data is invalid.

**-330 <Power-on Test Failed>**

Error conditions are presented at the display.

See Tables G-1.

**-340 <Self Test Failed>**

Parametric board failure>

See Chapter 6, \*TST? and Appendix G, Table G-2.

**-350 <Too Many Errors>**

More than ten error conditions are present.

Error code -350 was loaded into the error queue replacing the last error, error number 10.

<b>Error Code</b>	<b>Query Errors</b>
-------------------	---------------------

The occurrence of query errors also set bit two (QYE) of the standard event status register (ESR).

**-400 <Generic Query Error>**

An unspecified query error has occurred. Check for deadlock, unterminated, or interrupted actions.

**:SYST:DERR?**

Device dependent error conditions are reported in response to the :DERR? query.

**Table H-3. :SYSTEM:DError? Error Messages**

Channel 1 Error Code	Channel 2 Error Code	Error Message
100	200	<Period - Width Ch. 1   2> PERIOD < 5.00ns If WIDTH ≥ 1.0ns then WIDTH ≤ 0.5×PERIOD else WIDTH ≤ 0.5×PERIOD - 0.5ns 5.00ns ≤ PERIOD < 20.0ns Width ≤ 0.7×PERIOD - 1.00ns PERIOD ≥ 20.0ns WIDTH ≤ 0.9×PERIOD - 5.00ns
101	201	<Period - Delay Ch. 1   2> If PERIOD < 2.00ns then DELAY = 0.00ns If 2.00ns ≤ PERIOD < 5.00ns then DELAY ≤ 0.5×PERIOD - 1.00ns If 5.00ns ≤ PERIOD < 20.0ns then DELAY ≤ 0.7×PERIOD - 2.00ns If PERIOD ≥ 20.0ns then DELAY ≤ 0.9×PERIOD - 6.00ns

**Table H-3. :SYSTem:DERRor? Error Messages (continued)**

Channel 1 Error Code	Channel 2 Error Code	Error Message
102	202	<p>&lt;Period - Dcyc Ch. 1   2&gt;</p> <p>PERIOD &lt; 5.00ns</p> <p>  If WIDTH ≥ 1.00ns</p> <p>    then WIDTH ≤ 0.5×PERIOD</p> <p>    else WIDTH ≤ 0.5×PERIOD - 0.50ns</p> <p>5.00ns ≤ PERIOD &lt; 20.0ns</p> <p>  then WIDTH ≤ 0.7×PERIOD - 1.00ns</p> <p>PERIOD ≥ 20.0ns</p> <p>  WIDTH ≤ 0.9×PERIOD - 5.00ns</p>
103	203	<p>&lt;Period - Double Ch. 1   2&gt;</p> <p>If PERIOD &lt; 5.00ns</p> <p>  then DOUBLE PULSE is not possible.</p> <p>If 5.00ns ≤ PERIOD &lt; 10.0ns</p> <p>  then DOUB ≤ 0.5×PERIOD</p> <p>If PERIOD ≥ 10.0ns</p> <p>  then DOUB ≤ 0.9×PERIOD - 4.00ns</p> <p>If WIDTH &lt; 1.00ns</p> <p>  then WIDTH ≤ 0.7(PERIOD-DOUB) - 1.50ns</p> <p>If 1.00ns ≤ WIDTH &lt; 10.0ns</p> <p>  then WIDTH ≤ 0.7(PERIOD-DOUB) - 1.00ns</p> <p>If WIDTH ≥ 10.0ns</p> <p>  then WIDTH ≤ 0.85(PERIOD-DOUB) - 2.50ns</p>

**Table H-3. :SYSTem:DERRor? Error Messages (continued)**

Channel 1 Error Code	Channel 2 Error Code	Error Message
104	204	<p>&lt;Width - Double Ch. 1   2&gt;</p> <p>If WIDTH &lt; 1.00ns  then WIDTH ≤ 0.8×DOUB - 1.10ns</p> <p>If WIDTH ≥ 1.00ns  then WIDTH ≤ 0.8×DOUB - 0.60ns</p>
105	205	<p>&lt;Double - Dcyc Ch. 1   2&gt;</p> <p>If WIDTH &lt; 1.00ns  then WIDTH ≤ 0.8×DOUB - 1.10ns</p> <p>If WIDTH ≥ 1.00ns  then WIDTH ≤ 0.8×DOUB - 0.60ns</p>
106	206	<p>&lt;Trigger - Dcyc Ch. 1   2&gt;</p> <p>:INPut:TRIG:MODE TRIGger and  :PULSe:TIMing:DutyCYCle:MODE ON  are incompatible.</p>
108	208	<p>&lt;Excessive Slopes Ch. 1   2&gt;</p> <p>The leading and trailing edge transition times have been set  in such a way that the signal will not reach full amplitude.</p>

---

## Conflicts

The conflicts are identical to the device dependent error conditions listed in Table H-3. The codes are listed in Table H-4.

**Table H-4. Conflict Error Message**

Conflict	Channel 1	Channel 2
	:SYSTem:DERRor?	:SYSTem:DERRor?
PERIOD-WIDTH	100	200
PERIOD-DELAY	101	201
PERIOD-DCYC	102	202
PERIOD-DOUB	103	203
WIDTH-DOUB	104	204
DOUB-DCYC	105	205
TRIG-DCYC	106	206
Excessive	108	208





# **Sales and Service Office Directory**

---

## **Worldwide Sales and Support**

Hewlett-Packard products are sold and supported worldwide through HP offices.

To contact the closest HP Sales and Service Office, please check your telephone directory, or contact one of the major HP offices listed.

### **Asia**

Hewlett-Packard Asia Ltd.  
22/F, Bond Center  
West Tower  
89 Queensway, Central  
Hong Kong  
G.P.O. Box 863, Hong Kong

Telephone: 5-84 48 77 7  
Telex: 76793 HPA HX  
Cable: HPASIAL TD

### **Canada**

Hewlett-Packard (Canada) Ltd.  
6877 Goreway Drive  
Mississauga  
Ontario L4V 1M8  
Canada

Telephone: (416) 678-9430  
Telex: 069-8644

**Worldwide Sales and Support**

**Eastern Europe**

Hewlett-Packard GmbH  
Lieblgasse 1  
P.O. Box 72  
1222 Vienna  
Austria

Telephone: (222) 2500-0  
Telex: 13 4425 HEPA A

**Northern Europe**

Hewlett-Packard S.A.  
V.D. Hooplaan 241  
P.O. Box 999  
118 LN 15 Amstelveen  
The Netherlands

Telephone: 20 547 9999  
Telex: 189 19 hpner

**South East Europe**

Hewlett-Packard S.A.  
World Trade Center  
110 Avenue Louis-Casai  
1215 Cointrin  
Geneva  
Switzerland

Telephone: (022) 98 96 51  
Telex: 27225 hpser



## Worldwide Sales and Support

### **Middle East and Central Africa**

Hewlett-Packard S.A.  
Middle East/Central Africa Sales H.Q.  
7, Rue du Bois-du-Lan  
P.O. Box 364  
1217 Meyrin 1  
Geneva  
Switzerland

Telephone: (022) 83 12 12  
Telex: 27835 hmea  
Cable: HEWPACKSA Geneve

### **United Kingdom**

Hewlett-Packard Ltd.  
Nine Mile Ride  
Wokingham  
Berkshire, RG11 3LL

Telephone: 0344 773 100  
Telex: 848805

### **United States of America**

Customer Information Center  
(800) 752-0900  
6.00AM to 5PM Pacific Time

### **Eastern USA**

Hewlett-Packard Co.  
4 Choke Cherry Road  
Rockville  
MD 20850

Telephone: (301) 948-6370

**Worldwide Sales and Support**

**Midwestern USA**

Hewlett-Packard Co.  
5201 Tollview Drive  
Rolling Meadows  
IL 60008

Telephone (312) 255-9800

**Southern USA**

Hewlett-Packard Co.  
2000 South Park Place  
Atlanta  
GA 30339

Telephone: (404) 955-1500

**Western USA**

Hewlett-Packard Co.  
5161 Landershim Boulevard  
North Hollywood  
CA 91601

Telephone: (818) 505-5600

**Other International Areas**

Hewlett-Packard Co.  
Intercontinental Operations  
3495 Deer Creek Road  
Palo Alto  
CA 94304

Telephone: (415) 857-1501

Telex: 034-8300

Cable: HEWPACK



## Worldwide Sales and Support

### **Argentina**

Buenos Aires  
Phone: 541-11-1441

### **Australia**

Blackburn, Victoria  
Phone: 61-3-895-2895  
Sydney, N.S.W.  
Phone: 61-2-888-4444

### **Austria**

Vienna  
Phone: 43-222-2500

### **Belgium**

Brussels  
Phone: (02)32-2-761-31-11

### **Brazil**

Alphaville  
Phone: (011)421.1311

### **Canada**

Edmonton, Alberta  
Phone: (403)486-6666

**Worldwide Sales and Support**

**Denmark**

Birkerod  
Phone: 45-02-81-6640

**Finland**

Espoo  
Phone: (90)757-1011

**France**

Les Ulis  
Phone: 33-6-907-7825

**German Federal Republic**

Bad Homburg  
Phone: (06172)400-0  
Boeblingen  
Phone: (07031)645-0

**Hong Kong**

Hong Kong  
Phone: 5 848 7777

**Italy**

Cernusco Sul Naviglio  
Phone: (02)923691



## Worldwide Sales and Support

### Japan

Yokogawa Hewlett-Packard  
Osaka  
Phone: (06)304-6021  
Sagamihara  
Phone: 0427 59-1311

### Malaysia

Kuala Lumpur  
Phone: 03-2986555

### The Netherlands

Amstelveen  
Phone: (020)547-6911

### Norway

Oesteraas  
Phone: 47-2-24-6090

### Saudi Arabia

HP Distributor;  
Modern Electronics Establishment  
Riyadh  
Phone: 491,97-15

**Worldwide Sales and Support**

**Singapore**

Singapore  
Phone: 273 7388

**South Africa**

Sandton, Transvaal  
Phone: 27-11-802-5111

**Spain**

Mirasierra, Madrid  
Phone:

**Sweden**

Spanga  
Phone: (08) 750-2000

**Switzerland**

Widen  
Phone: 41-57-31-2111

**Taiwan**

Taipei  
Phone: (02)712-0404





**Worldwide Sales and Support**

**United Kingdom**

Bracknell  
Phone: 44/344/424-898  
Wokingham  
Phone: 734/784-774

**United States**

Fullerton, California  
Phone: (714)999-6700

Los Angeles, California  
Phone: (213)337-8000

Palo Alto, California  
Phone: (415)857-5027

Santa Clara, California  
Phone: (408)988-7000

Englewood, Colorado  
Phone: (303)649-5000

Atlanta, Georgia  
Phone: (404)955-1500

Rolling Meadows, Illinois  
Phone: (312)255-9800

Rockville, Maryland  
Phone: (301)948-6370

**Worldwide Sales and Support**

Andover, Massachusetts  
Phone: (617)682-1500

Novi, Michigan  
Phone: (313)349-9200

Paramus, New Jersey  
Phone: (201)265-5000

Richardson, Texas  
Phone: (214)231-6101

Bellevue, Washington  
Phone: (206)643-4004

**Venezuela**

Caracas  
Phone: (582)239-4133







# Index

---

- I** 1 PULSE, 5-6
  
- A** AC line voltage, v, A-3  
Address, 2-9, 5-7, 5-29  
    Changing, 2-9  
ADS, 2-9, 5-7  
Ambient Temperature, 5-2  
AMPL, 5-8  
Amplitude. *See* Output, Amplitude  
AUTO, 5-9  
Autotransformer, A-4
  
- B** BURST, 5-10
  
- C** Channel Number, 7-13, 7-18  
Clear Status Command, 6-2  
    \*CLS, 6-2  
Command. *See* Message  
    Execution, 3-2  
Common Command, 4-2  
COMP, 5-11  
Complement, 5-11, B-11  
Conflict, 3-3, 5-2  
Continuous Waveform, 5-9  
Cooling, A-6  
COUNT, 5-12

- D**
  - DCYC, 5-13
  - default address, 3-2
  - Delay, B-3
  - DELAY, 5-15
  - Device Command, 4-2
  - Disable, B-11
  - DISABLE, 5-16
  - DOUB, 5-18
  - Double Pulse, 5-18, B-3
  - Double Pulse Delay, 7-38
  - Double Pulse Enable/Disable, 7-39
  - Duty Cycle, 5-13, B-7. *See also* Pulse On-Time, Duty Cycle
  - Duty Cycle Enable/Disable, 7-42
  
- E**
  - Earth Terminal, A-1
  - Environment
    - Operating, A-6
  - Environmental Conditions, B-12
  - Error, 3-3, 3-5, 7-49, H-9
    - Conflict, H-15
    - Device, H-12
    - Device Dependent, 7-48. *See also* Parameter Conflict
    - Local Message, 3-3
    - Power-on, 2-1
    - Power-On Self-Test, H-1
    - Remote Message, 3-4
    - Self-Test, H-6
  - ERROR, 5-20
  - Error Detection, B-1
  - ERROR Light, 2-4
  - Error Queue, 3-12
  - \*ESE, 6-3
  - ESE, 3-11, 6-3, 6-5
  - \*ESE?, 6-5
  - ESR, 3-10-11, 6-3, 6-6
  - \*ESR?, 6-6
  - E. WIDTH, 5-22
  - EXCESSIVE, 5-24
  - EXCESSIVE LED, 2-4
  - External Input, 5-25, B-8. *See also* EXT INPUT
  - External Width, 5-22

EXT INPUT, 2-10, 5-25

**F** Free Run, 5-9  
Front Panel, 2-3, 5-1  
Fuse, A-3

**G** GATE, 5-27

**H** HIGH, 5-28  
High Level. *See* Output, High Level  
HP-IB, 2-8, A-7, B-11. *See also* Interface  
HP-IB Connector, A-8  
Humidity, A-6

**I** Identification Query, 6-7  
\*IDN?, 6-7  
:INPut, 7-1  
Input Queue, 3-12  
:INPut:TRIGger, 7-6  
:INPut:TRIGger:MODE, 7-7  
:INPut:TRIGger:MODE?, 7-8  
:INPut:TRIGger:SLOPe, 7-9  
:INPut:TRIGger:SLOPe?, 7-9  
:INPut:TRIGger:STATe, 7-10  
:INPut:TRIGger:STATe?, 7-11  
:INPut:TRIGger:THReshold, 7-12  
:INPut:TRIGger:THReshold?, 7-12  
Inspection  
  Initial, A-1  
Instrument Features, 1-1  
Interface, 2-9  
Interface Command, 4-1  
Interface Type, 3-4  
Internal Memory, 2-2

**K** Key Queue, 3-13

**L**

language, 4-1  
LCL, 2-9, 5-29  
LEAD, 5-30  
Leading Edge, 5-30, 7-20  
Learn Device Setting Query, 6-8  
LEDs  
    blinking, 2-4  
Limit, B-11  
LIMIT, 5-32  
Limiting Condition, B-1  
Line Voltage, A-3  
Load Resistance, 5-2, B-1  
Local, 5-29  
Local Functions, 5-1  
Local Lockout, 5-29  
Local Mode, 2-3  
LOW, 5-33  
Low Level. *See* Output, Low Level  
\*LRN?, 6-8

**M**

Maintenance, A-9  
MAN, 5-34  
Manual Trigger, 5-34  
Master Summary Status, 3-7. *See also* MSS  
MAV, 3-12  
MEM, 5-35  
Memory, 5-35, B-11  
    Recall, 5-41  
    Save, 5-43  
Message  
    Program, 4-3  
    Response, 4-4  
    Terminator, 4-3  
Message Available, 3-12  
Messages  
    Coupled, 4-3  
    Long Form, 4-2  
    Short Form, 4-2



MSS, 3-7

- OFFS, 5-36
  - Offset, 5-36. *See also* Output, Offset
  - On-Time. *See* Pulse On-Time
  - \*OPC, 6-11
  - \*OPC?, 6-12
  - Operating Mode, B-9
    - Automatic, 5-9, 7-7
    - Burst, 5-10, 5-12, 7-7, 7-19
    - Current, 7-8
    - External Width, 5-22, 7-8
    - Gate, 5-27, 7-7
    - Trigger, 5-49, 7-7
  - Operation Complete Command, 6-11
  - Operation Complete Query, 6-12
  - :OUTPut, 7-1, 7-13
  - Output
    - Amplitude, 5-8, 7-25
    - Amplitude:Limit, 7-29
    - High Level, 5-28, 7-26, B-6
    - High Level Limit, 7-30
    - Inverting, 7-16
    - Limit, 5-32, 7-28
    - Low Level, 7-32, B-6
    - Low Level Limit, 7-30
    - Main, B-8
    - Offset, 7-34
    - Offset Limit, 7-31
  - OUTPUT, 2-10, 5-37
  - OUTPUT, 2-10, 5-37
  - OUTPUT Enable/Disable, 7-14
  - OUTPUT Enable/Disable, 7-17
  - Output Levels, B-6
  - OUTPut:PULSe, 7-14
  - :OUTPut:PULSe:CState, 7-14
  - :OUTPut:PULSe:CState?, 7-15
  - :OUTPut:PULSe:POLarity, 7-16
  - :OUTPut:PULSe:POLarity?, 7-16
  - :OUTPut:PULSe:STATe, 7-17
  - :OUTPut:PULSe:STATe?, 7-17

Output Queue, 3-12

- P** Parameter, 5-2
- Parameter Conflict, 2-4, 3-4
- Parameter Selection, 2-3
- Parser, 3-2
- Period, 7-44, B-2
- PERIOD, 5-38
- Polling, 3-4
- Power
  - cable, vii
  - Cable, A-4
  - Disconnecting, A-1
  - requirements, v, A-2
- Power-Off, 5-39
- Power Off, 2-2
- Power-On, 3-1, 5-39
- Power-on State, 2-1
  - Error, 2-2
- Power Source, A-2
- Program Messages, 2-8
- :PULSe, 7-2, 7-18
- :PULSe:COUNt, 7-18
- Pulse Count, 5-12, 7-19
- :PULSe:COUNt?, 7-19
- Pulse Delay, 5-15, 7-36
  - Fixed, 5-15, 7-36
- :PULSe:EDGE, 7-20
- :PULSe:EDGE:LEADing, 7-20
- :PULSe:EDGE:LEADing?, 7-21
- :PULSe:EDGE:TRAILing, 7-22
- :PULSe:EDGE:TRAILing?, 7-23
- :PULSe:LEVel, 7-24
- :PULSe:LEVel:AMPLitude, 7-24
- :PULSe:LEVel:AMPLitude?, 7-25
- :PULSe:LEVel:HIGH, 7-26
- :PULSe:LEVel:HIGH?, 7-26
- :PULSe:LEVel:LIMit, 7-28
- :PULSe:LEVel:LIMit?, 7-29
- :PULSe:LEVel:LIMit:AMPLitude?, 7-29
- :PULSe:LEVel:LIMit:HIGH?, 7-30

- :PULSe:LEVel:LIMit:LOW?, 7-30
- :PULSe:LEVel:LIMit:OFFSet?, 7-31
- :PULSe:LEVel:LOW, 7-32
- PULSe:LEVel:LOW?, 7-32
- :PULSe:LEVel:OFFSet, 7-34
- :PULSe:LEVel:OFFSet?, 7-34
- Pulse On-Time
  - Duty Cycle, 5-13, 7-41
  - Width, 7-46
- Pulse Performance, B-6
- :PULSe:TIMing, 7-35
- :PULSe:TIMing:DELay, 7-36
- :PULSe:TIMing:DELay?, 7-37
- :PULSe:TIMing:DOUBle, 7-38
- :PULSe:TIMing:DOUBle?, 7-39
- :PULSe:TIMing:DOUBle:MODE, 7-39
- :PULSe:TIMing:DOUBle:MODE?, 7-40
- :PULSe:TIMing:DutyCYCle, 7-41
- :PULSe:TIMing:DutyCYCle?, 7-41
- :PULSe:TIMing:DutyCYCle:MODE, 7-42
- :PULSe:TIMing:DutyCYCle:MODE?, 7-43
- :PULSe:TIMing:PERiod, 7-44
- :PULSe:TIMing:PERiod?, 7-45
- :PULSe:TIMing:WIDTh, 7-46
- :PULSe:TIMing:WIDTh?, 7-46

**R**

- RANGE, 5-40
- \*RCL, 6-13
- RCL, 5-41
- Recall Command, 6-13
- Remote Command, 4-1
- Remote Control, 5-42
- Remote Programming, 2-8
- Request Service, 3-7. *See also* RQS
- Reset Command, 6-14
- Response Messages, 2-8
- RMT, 2-9, 5-42
- RQS, 3-7
- \*RST, 6-14

**S** Safety considerations, iii, A-1  
Sales offices, I-1  
\*SAV, 6-16  
Save, 6-16  
SAVE, 5-43  
Self-test  
    power-on, 2-1  
Self-Test Query, 6-22  
Service offices, I-1  
Service Request, 3-4, 5-46  
Service Request Enable Register Command, 6-17  
Service Request Enable Register Query, 6-19  
Set, B-11  
SET, 5-44  
Setting, 2-2, 6-8  
    Standard, 6-14  
Shipment, A-7  
Slope, 5-45  
Specifications, B-1  
\*SRE, 6-17  
SRE, 3-9, 6-17, 6-19  
\*SRE?, 6-19  
SRQ, 2-9, 5-46  
Standard Event Status Enable Command, 6-3  
Standard Event Status Enable Query, 6-5  
Standard Event Status Enable Register. *See* ESR  
Standard Event Status Register. *See* ESR  
Standard Event Status Register Query, 6-6  
Status, 2-9, 3-4  
Status Byte Register. *See* STB  
Status Byte Register Query, 6-20  
STB, 3-7, 3-9, 6-17, 6-20  
\*STB?, 6-20  
Storage, A-7  
SYST:DERR, 3-5  
:SYSTEM, 7-4, 7-47  
:SYSTEM:DERRor?, 7-48, H-12  
:SYSTEM:ERRor?, 7-49, H-9  
:SYSTEM:KEY, 7-50  
:SYSTEM:KEY?, 7-51  
:SYSTEM:SET, 7-52

:SYSTem:SET?, 7-52

SYST:ERR, 3-10

SYST:KEY, 3-13

- T** Temperature, A-6  
THRE, 5-47  
Threshold, 5-47  
Timing Parameters  
    Measurement Conditions, B-2  
TRA, 5-48  
Trailing Edge, 5-48, 7-22  
Transition Time  
    Leading Edge, 5-30, 7-20  
    Trailing Edge, 5-48, 7-22  
Transition Times, B-4  
\*TRG, 6-21, 7-10  
TRIG, 5-49  
Trigger, 5-49  
Trigger Command, 6-21  
Trigger Enable/Disable, 7-10  
Trigger Output, 5-50, B-9. *See also* TRIG OUTPUT  
Trigger Slope, 7-9  
Trigger Threshold, 7-12  
TRIG OUTPUT, 2-10, 5-50  
\*TST?, 6-22, H-6
- U** Under-Programming, 5-5  
Units, 5-51
- V** VERNIER, 5-52  
Voltage  
    AC line, v, A-3
- W** \*WAI, 6-23  
Wait to Continue Command, 6-23  
Warm-Up, B-1  
Warm-Up Period, 5-2  
Width, B-2  
WIDTH, 5-53  
Width Enable/Disable, 7-42

